

VLT® 5000 / 5000 FLUX / 6000 HVAC / 8000 AQUA



Operating Instructions

Profibus DP V1



■ **Contents**

Introduction	3
About this manual	3
Assumptions	4
Background knowledge	4
Profibus DP	5
Baudrate	5
Profibus DP V1	5
The PROFIBUS option card	6
Master-controlled frequency converters	6
Bus topology	7
Features of DP (Distributed Periphery)	7
Rapid Cyclical transmission with PPO using DP	7
Profibus DP V1	8
Principle of data exchange by Profibus DP V0/DP V1	8
Cable lengths and number of nodes	9
Physical connection	11
Protective measures for EMC	11
Cable connection FCM 300	11
Connection of the cable screening	11
Earthing	11
Bus connection	11
Diagram bus connection	12
The PROFIBUS option card	12
LEDs	13
Address switches	14
Frequency converter response time behaviour	16
Time behaviour during system update	16
PPO description	17
Communication connections	17
PPO description (Overview)	17
PCA interface	18
PCA processing	18
Parameter description	19
Spontaneous messages	21
Spontaneous messages	21
SYNC and FREEZE	22
SYNC and FREEZE	22
SYNC/UNSYNC	22
FREEZE/UNFREEZE	22
Control word/Status word	23
Control word/Status word	23
Control word according to profdriveprofile	23
Status word according to profdriveprofile	25

Control word according to fc standard	27
Status word according to fc standard	28
Bus reference value	29
Bus reference value	29
Examples	30
Example 1: PCV Channel	30
Example 2: Process data from the frequency converter	31
Example 3: Array treatment	32
GSD file	34
DP V1 Identifications	34
Parameters	35
VLT frequency converter parameters	35
Parameter access	42
Read/Write on VLT frequency converters	42
Warning and alarm messages	43
Warnings and alarm messages	43
Spontaneous messages	43
Additional display readings	43
Warning word, extended Status word and Alarm word	44
Station address	46
Extended Diagnosis	47
Parameter list	48
Appendix	58
Glossar	58
Abbreviations used	59

■ **Introduction**

Copyrights, Limitation of Liability and Revision Rights

This publication contains information proprietary to Danfoss A/S. By accepting and using this manual the user agrees that the information contained herein will be used solely for operating equipment of Danfoss A/S or equipment from other vendors provided that such equipment is intended for communication with Danfoss equipment over a PROFIBUS serial communication link. This publication is protected under the Copyright laws of Denmark and most other countries.

Danfoss A/S does not warrant that a software program produced according to the guidelines provided in this manual will function properly in every physical, hardware or software environment.

Although Danfoss A/S has tested and reviewed the documentation within this manual, Danfoss A/S makes no warranty or representation, either express or implied, with respect to this documentation, including its quality, performance, or fitness for a particular purpose.

In no event shall Danfoss A/S be liable for direct, indirect, special, incidental, or consequential damages arising out of the use, or the inability to use information contained in this manual, even if advised of the possibility of such damages. In particular, Danfoss A/S is not responsible for any costs including but not limited to those incurred as a result of lost profits or revenue, loss or damage of equipment, loss of computer programs, loss of data, the costs to substitute these, or any claims by third parties.

Danfoss A/S reserves the right to revise this publication at any time and to make changes in its contents without prior notice or any obligation to notify previous users of such revisions or changes.



NB!:

Note regarding Profibus FMS

If you want to run FMS you have to purchase as follows:

For VLT 5000:

175Z3722 (uncoated)

175Z3723 (coated)

For VLT 6000 HVAC:

175Z4207 (uncoated)

175Z4208 (coated)

It is NOT possible to run FMS from a VLT 5000 FLUX or a VLT 8000 AQUA.

This manual does not deal with Profibus FMS, only with Profibus DP. However, in the event that the communication is to be built up through Profibus FMS, you should request the description MG.10.E3.yy "Profibus Product Manual" which also contains a description of the Profibus FMS functions of the Profibus option card.

■ **About this manual**

This manual is intended as both an instruction manual and a reference guide. It only broaches the basics of the PROFIBUS DP protocol, and only when it is necessary to provide a sufficient understanding of the PROFIDRIVE implementation of the PROFIBUS profile for frequency converters (version 2, PNO) and of the PROFIBUS option card for the series VLT 5000/VLT 5000 Flux/VLT 6000 HVAC/VLT 8000 AQUA by DANFOSS.

Unit	Software version
FCD 300	Ver. 1.30
FCM 300	-
VLT 2800	Ver. 2.64
VLT 5000	Ver. 3.62
VLT 6000 HVAC	Ver. 2.41
VLT 8000 AQUA	Ver. 1.12

The above table shows from which software versions Profibus DP V1 is supported. The software version can be read-out in parameter 624 *Software versions*.

This manual gives detailed information of the DP V0 features supported, sufficient for most programming and maintenance activities. The DP V1 however is briefly described. For programming purposes the *Profibus DP V1 Design Guide* order number MG.90.EX.YY (X is the version number, and YY the language code) might be necessary.

It is suggested that readers who are not completely familiar with PROFIBUS DP or the profile for frequency converters review the relevant literature on these subjects.

Even if you are an experienced PROFIBUS programmer, we suggest that you read this manual in its entirety before you start programming, since important information can be found in all chapters.

The section *Quick start* deals with the quick start of the communication parameters for the DP communication.

The chapter *The Profibus option card* contains details regarding the PROFIBUS option card and the establishment of the physical connection.

Please refer to section *Timing* for information regarding the time behaviour.

The chapter *PPO description* presents an overview of the PPOs (informative data telegrams).

The PCA interface as a parameter interface in the PPO is explained in chapter *PCA interface*.

Section *Parameters and data type structures* contains the description of the parameter and data structure.

Chapter *Spontaneous messages* contains a description of spontaneous messages.

The response to the "Sync" and "Freeze" commands is explained in chapter *SYNC and FREEZE*.

The Control word and Status word as essential elements of the PPOs for the operational Control, as well as the bus reference value are explained in chapter *Bus reference value*.

Chapter *Examples* contains examples for the use of the PPOs. It is recommended that readers review the examples for a better understanding of the PPOs.

Chapter *Parameters* contains the frequency converter parameters specific to the Profibus. Warning and alarm messages and display readings specific to the Profibus are described in chapter *Warning and alarm messages*.

A parameter listing as an overview of all VLT 5000/VLT 5000 Flux/VLT 6000 HVAC/VLT 8000 AQUA parameters can be found in chapter *Parameter list*.

In chapter *Appendix* you will find the abbreviations used in this manual. The manual concludes with a short glossary and a detailed index for quick navigation.

If you are interested in learning more about the PROFIBUS protocol in general, we recommend that you consult the relevant, very comprehensive literature for this purpose.

■ Assumptions

The manual assumes that you are using a DANFOSS PROFIBUS DP option card, together with a DANFOSS VLT frequency converter, that you are using a PLC or a PC with a serial interface as master which supports all communication services for PROFIBUS, and that all requirements are met and all limitations are observed which arise from the PROFIBUS standard, the PROFIBUS profile of frequency converters, and the company-specific implementation of PROFIDRIVE, or those of the frequency converter drives.

The Profibus DP V1 is an extension of the former Profibus DP V0 functionality.

■ Background knowledge

The DANFOSS PROFIBUS option card is designed for the communication with all masters that comply with the PROFIBUS DP V0 and DP V1 standard. Thus, the assumption is made that you are familiar with the PC or PLC to be used as a master on your system. Any questions regarding the hardware or software of other suppliers are beyond the scope of this manual and outside the responsibility of DANFOSS.

In the event of questions concerning the configuration of the master-to-master communication or the configuration with a slave not manufactured by DANFOSS, you should refer to the information in the respective manuals.

■ Quick start

Details regarding the programming of the usual frequency converter parameters may be gathered from the manual for the VLT 5000/VLT 5000 FLUX/VLT 6000 HVAC/VLT 8000 AQUA series.

The communication is established by setting the parameters indicated below.

Details regarding the adjustment of the master are provided by the master manual and by those chapters in this manual that deal with the particulars of the PROFIBUS interface.

**NB!:**

The required GSD file is available on the Internet at <http://www.danfoss.com/drives>

Module consistency means that a specific portion of the PPO is defined as a connected module. The parameter interface (PCV, length of 8 bytes) of the PPO always has module consistency.

Word consistency means that a specific portion of the PPO is divided into individual data sectors of word length (16 bits).

The process data of the PPO may have either module consistency or word consistency, as desired.

Some PLCs, such as Siemens S7, require special functions to call modules that are longer than 4 bytes (in the case of Siemens: "SFC", see master manual). This means that the PCV interfaces of the PPOs can only be called through the SFC functions in the case of Siemens (S7).

■ Profibus DPParameter 904

The desired informative data telegram (PPO) is setup in master configuration. The actual PPO type can be read out in P904. The master sends the PPO type in a configuration telegram in the Profibus DP start phase.

Parameter 918

This sets the address of the frequency converter station – one specific address per frequency converter. For further information, please refer to the section Station address in this manual.

Parameter 502 -508

By setting the parameters 502-508 you will be able to select have to control over the bus.

Parameter 512

Allows the choice of Control word/Status word type. For further information, please refer to the section Control word/Status word this manual.

**NB!:**

In order to activate a change of parameter 918 the power of the frequency converter must be cycled.

■ Profibus DP V1

A detailed description of the DV V1 features supported can be found in the "Profibus DP V1 Design Guide" order number MG.90.EX.YY.

Further specifications might be helpful:

- Technical Guide "PROFIBUS -DP Extensions to EN 50170 (DPV1)" V2.0, April 1998, Order no. 2.082
- Draft PROFIBUS Profile PROFIDRIVE Profile Drive Technology V3.0 September 2000, Order no. 3.172

■ Baudrate

The FCM 300, FCD 300 and VLT 2800 adjust automatically to the Baudrate configured from the master.

**NB!:**

When configuring the PPO types, a distinction is made between module consistency and word consistency:

■ Master-controlled frequency converters

The PROFIBUS Fieldbus was designed to give you unprecedented flexibility and command over your controlled system. The PROFIBUS will perform as an integrated part of your frequency converter, giving you access to all parameters relevant to your application. The frequency converter will always act as a slave, and together with a master it can exchange a multitude of information and commands. Control signals such as speed reference, start / stop of motor, reverse operation, etc. are transmitted from the master in the form of a telegramme. The frequency converter acknowledges receipt by transmitting status signals, such as running, on reference, motor stopped and so on to the master. The frequency converter may also transmit fault indications, alarms and warnings to the master, such as Overcurrent or Phaseloss.

The PROFIBUS communicates in accordance with the PROFIBUS field bus standard, EN 50170, part 3. It can thus exchange data with all masters that meet this standard; however, this does not mean that all services available in the PROFIDRIVE profile standard are supported. The PROFIBUS profile for frequency converters (version 2 and partly version 3, PNO) is a part of PROFIBUS which supports only those services that concern applications with speed control.

Communication partners

In a control system the frequency converter will always act as a slave, and as such it may communicate with a single master or multiple masters depending on the nature of the application. A master may be a PLC or a PC that is equipped with a PROFIBUS communication card.

■ Bus topology

Single master operation with DP V0

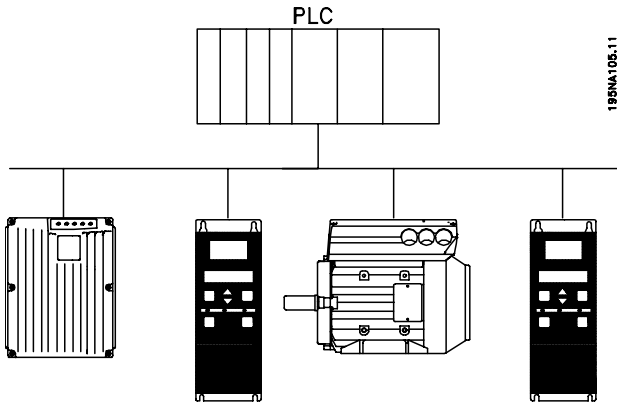

- Single master
- PLC communicates with telegrams of constant length
- Fits to time critical requirements

Cyclical transmission (PLC)

1. Setpoint transmission
2. Actual value feedback
3. New set points computed
4. New set point transmission
5. Parameter Read - using PCV channel
6. Parameter Write - using PCV channel
7. Read parameter description - using PCV channel

■ Features of DP (Distributed Periphery)

- Is used by several PLC manufacturers for remote peripheral I/O communication.
- Supports cyclical communication.
- SRD (Send Receive Data) service gives fast cyclical exchange of process data between master and slaves.
- Freeze and synchronize function is supported.
- Fixed data structure.
- Fixed telegram size.
- Occupies I/O memory space in PLC proportional to the number of slaves employed, which may

limit the number of participants. Additional data require additional I/O memory space.

DP should be used when fast cyclical process control is needed. Such a concept would typically call for single master operation with a limited number of slave stations. A high number of slaves will increase the system response time.

This could also be the case where control loops are closed over the bus. As a very fast alternative it is of course possible to close the control loop outside the bus.

The PROFIBUS option card

■ Rapid Cyclical transmission with PPO using DP

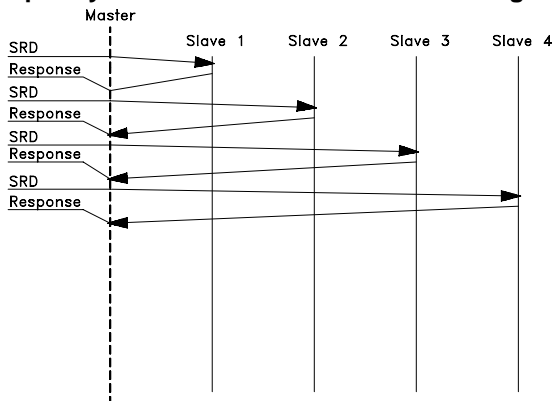

Control of the drives during normal operation is often very time critical, but it involves very few data, such as control commands and speed reference. DP is optimized for fast cyclical communication.

Parameter up-/downloads can be achieved by using the PCV part of the so-called Parameter - Process data Objects - PPO types 1, 2 or 5, see drawing in paragraph PPO description.

DANFOSS
A1750A241.10

■ Profibus DP V1

The Profibus DP extension DP V1 offers additional to the cyclical data communication an acyclical communication. This feature can be used by a DP master type 1 (e.g. PLC), as well as a DP master type 2 (e.g. PC tool).

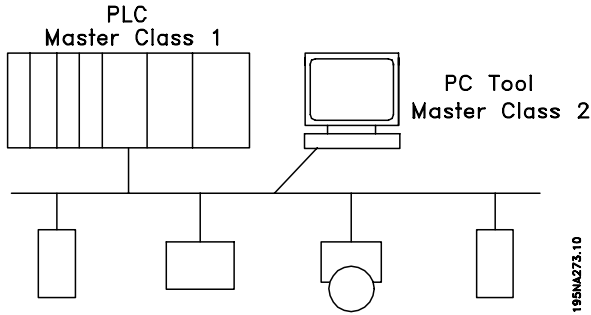

Features of a Master type 1 connection

- Cyclical data exchange (DP V0).
- Acyclical read/write on parameters.

The acyclical connection is fixed, and can not be changed during operation.

Features of a Master type 2 connection:

- Initiate / Abort acyclical connection.
- Acyclical read/write on parameters.

The acyclical connection can dynamically be established (Initiate) or removed (Abort) even when a master class 1 is active on the network.

The DP V1 acyclical connection can be used for general parameter access as an alternative to the PCV parameter channel.

■ Principle of data exchange by Profibus DP V0/DP V1

In a DP cycle the MC 1 will first update the cyclical process data for all slaves in the system. After that the MC 1 has the possibility of sending one acyclical message to one slave. If a MC 2 is connected, the MC 1 will handle over the Token to MC 2 who now is aloud to send one acyclical message to one slave. After that, the token is handed back to the MC 1, and a new DP cycle is started.

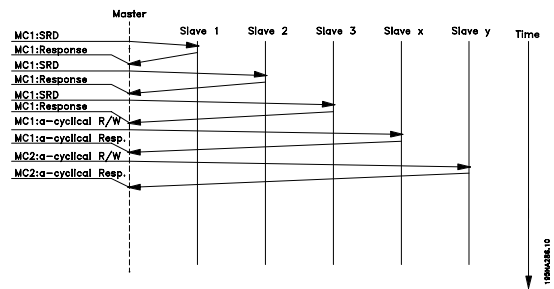

MC1: Master Class 1

VLT® 5000/ 5000 FLUX/ 6000 HVAC/ 8000 AQUA PROFIBUS

■ Cable lengths and number of nodes

The maximum cable length of a segment depends on the transmission speed. The total cable length includes stub lines, if applicable. A stub line is the connection from the main bus cable to each node if a "T" connection exists instead of a direct connection of the main bus cable to the nodes; cf. the stub line length. The following table shows the maximum permitted cable lengths and the maximum number of nodes or frequency converters with 1, 2, 3 or 4 bus segments.

Please note that a repeater switched between two segments represents a node in both segments. The number of frequency converters is based on

a system with only one master. In the case of multiple masters, the number of frequency converters must be reduced accordingly.

The total stub line length of a segment is limited as follows:

Stub line length	
Transmission speed	Max. stub line length per segment [m]
9.6-93.75 kBaud	96
187.5 kBaud	75
500 kBaud	30
1.5 MBaud	10
3-12 MBaud	none

Maximum total bus cable length

Transmission speed	1 segment: 32 nodes (31 frequency converters) [m]	2 segments: 64 nodes (1 repeater, 61 frequency converters) [m]	3 segments: 96 nodes (2 repeater, 91 frequency converters) [m]	4 segments: 128 nodes (3 repeater, 121 frequency converters) [m]
9.6-187.5 kBaud	1000	2000	3000	4000
500 kBaud	400	800	1200	1600
1.5 MBaud	200	400	600	800
3-12 MBaud	100	200	300	400

The PROFIBUS option
card

VLT® 5000/ 5000 FLUX/ 6000 HVAC/ 8000 AQUA PROFIBUS

The indicated lengths in the tables are valid on the condition that bus cables with the following properties are used:

- Impedance: 135 to 165 Ohm at a measuring frequency of 3 to 20 MHz
- Resistance: < 110 Ohm/km
- Capacity: < 30 pF/m
- Damping: max. 9 dB across the entire cable length
- Cross-section: max. 0.34 mm pursuant to AWG 22
- Wire type: twisted pair, 1 x 2 or 2 x 2 or 1 x 4 conductors
- Shielding copper-braided or braided and foil laminated

It is recommended to use the same cable type throughout the entire network in order to avoid mismatches of the impedance.

The figures in the following description indicate the maximum permitted number of stations in each segment. These figures do not refer to the station addresses, since each station in the network must have an unambiguous address.

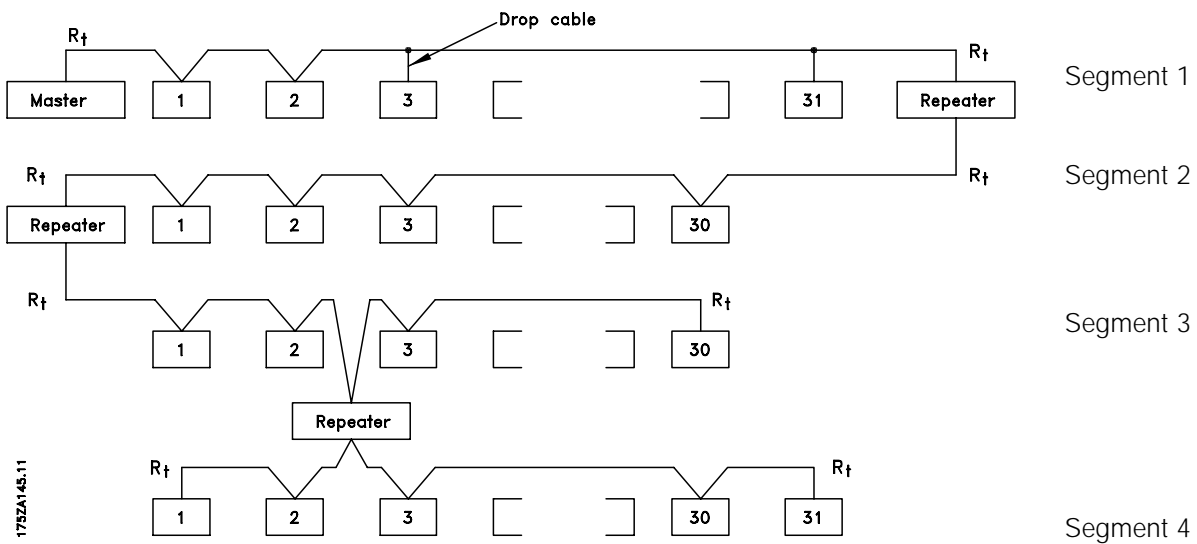

1752A145.11

■ **Physical connection**

The PROFIBUS option card will be connected to the bus line (data line) at terminals 62 and 63. Data line "B" (TxD/RxD-P) will be connected to terminal 62 and data line "A" (TxD/RxD-N) to terminal 63. A master with a voltaically insulated bus driver and overvoltage protection (e.g. Z diode) is recommended.

■ **Protective measures for EMC**

It is recommended to carry out the following protective measures for EMC in order to ensure a trouble-free operation of the PROFIBUS network. Additional notes concerning the subject of EMC can be found in the project manual for the VLT 5000 series (MG.50.Cx.yy) and in the manual for the Profibus master.



NB!:

The applicable national and local regulations, for example with respect to protective earthing, must be observed.

■ **Cable connection FCM 300**

The PROFIBUS communication cable must be kept away from motor and brake resistor cables to avoid coupling of high frequency noise from one cable to the other. Normally a distance of 200 mm is sufficient, but it is generally recommended to keep the greatest possible distance between the cables, especially where cables are running in parallel over long distances.

If the PROFIBUS cable has to cross a motor and braking resistance cable, it should occur at a 90° angle.

■ **Connection of the cable screening**

The shielding of the PROFIBUS cable always needs to be of a large-area, low-impedance type on both sides. As a matter of principle, the screen should be put up with a large area and low impedance at all PROFIBUS stations. It is very important to have an earth connection with low impedance even at high frequencies. This can be achieved by connecting the shield surface to earth, for example with the help of a cable bow or a conductive cable connector.

The frequency converter is equipped with various terminals and supports in order to provide a flawless shielding of the PROFIBUS cable. The shield connection is shown in the following diagram.

■ **Earthing**

It is important to connect all stations linked to the PROFIBUS network to the same earth potential. The earthing must have a low high-frequency impedance. This can be achieved by connecting a protective housing surface which is as large as possible to earth, for example by mounting the frequency converter to a conductive rear wall.

Especially in the case of large distances between the stations of a PROFIBUS network, the additional use of potential equalization cables to connect the individual stations to the same earth potential may be necessary.

■ **Bus connection**

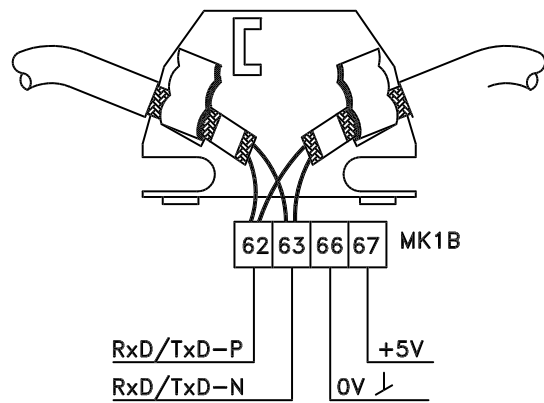

62 = RxD/TxD-P red cable

63 = RxD/TxD-N green cable

■ Diagram bus connection

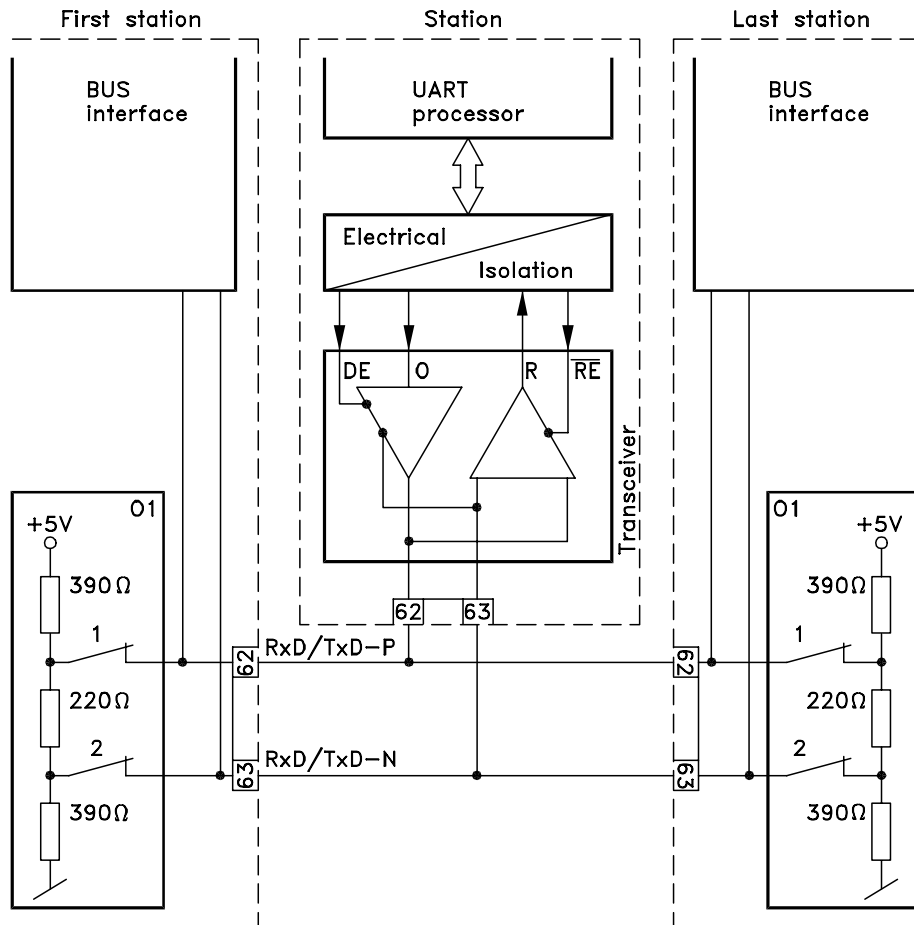

175HA099.11

It is important to terminate the bus line correctly. Mismatches of the impedance may lead to reflections in the line and cause incorrect transmissions.

- The PROFIBUS option card is equipped with a suitable termination which can be activated by the switches 1 and 2 at the switch block S1 directly to the right above the terminal block MK 1B. The bus termination is active when the switch is in the "ON" position.

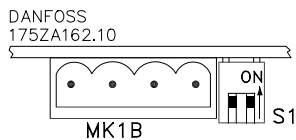

NB!:

The switches must never be set in opposite directions. Both switches must be set to ON or OFF.

- Most masters and repeaters are equipped with their own termination.
- If an internal termination circuit in the form of three resistors is connected to the bus line, a 5 V direct voltage must be used. Attention: please make sure that it is voltaically separated from the power supply cable.

■ The PROFIBUS option card

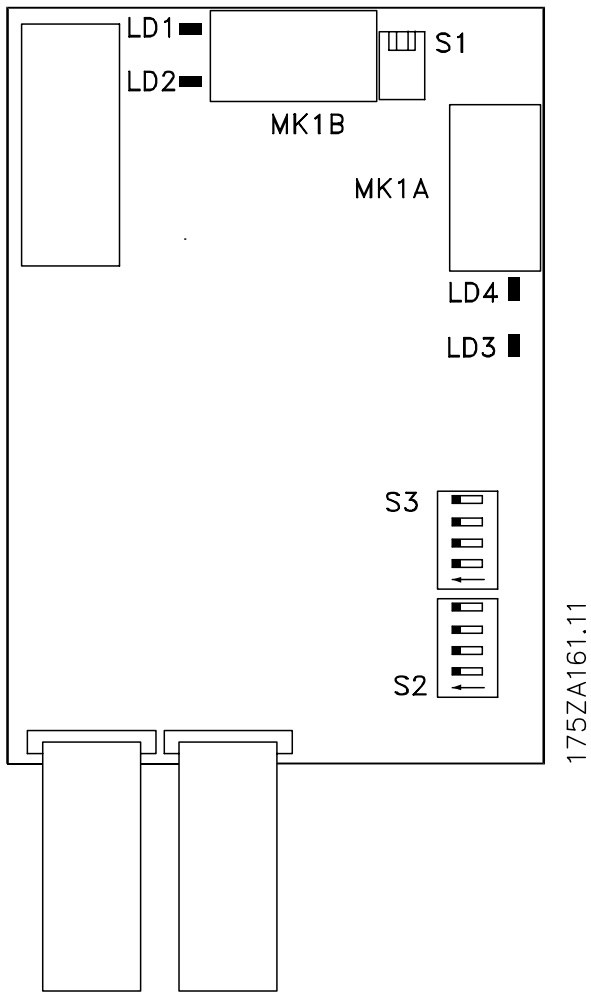

■ LEDs

There are four LEDs on the PROFIBUS option card:

LD1 and LD4: Flickering (very rapid blinking), when data are being exchanged through the option card.
Comment: with each "flicker" of the LEDs, the frequency converter is sending a telegram.

LD2 and LD3: Shining, when the option card is initialized and ready for the data exchange, or when data are already being exchanged. Blinking, when the function for the automatic baud rate determination attempts to determine the current baud rate.
Note: a faulty connection of the data line may also cause blinking of the LEDs. (see "Physical connection").

The PROFIBUS option card

VLT® 5000/ 5000 FLUX/ 6000 HVAC/ 8000 AQUA PROFIBUS

■ Address switches

The station address can be set in parameter 918 or through a hardware switch (S2, 1-4 and S3, 5-7 on the PROFIBUS option card).

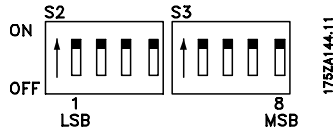

The setting of an address through parameter 918 is only possible when the address switches are set to > 125.

Each slave must have an unambiguous address. The address is the binary value set for the switches, cf. the table below. The modification of the address switches occurs during the next turn-on procedure. See also section *Station Address*.

Switches 1-7 (switch 8 is not used)	
	1 2 3 4 5 6 7
Address switch position (1= ON, 0=OFF)	
0	0 0 0 0 0 0 0
1	1 1 0 0 0 0 0
2	0 1 0 0 0 0 0
3	1 1 0 0 0 0 0
4	0 0 1 0 0 0 0
5	1 0 1 0 0 0 0
6	0 1 1 0 0 0 0
7	1 1 1 0 0 0 0
8	0 0 0 1 0 0 0
9	1 0 0 1 0 0 0
10	0 1 0 1 0 0 0
11	1 1 0 1 0 0 0
12	0 0 1 1 0 0 0
13	1 0 1 1 0 0 0
14	0 1 1 1 0 0 0
15	1 1 1 1 0 0 0
16	0 0 0 0 1 0 0
17	1 0 0 0 1 0 0
18	0 1 0 0 1 0 0
19	1 1 0 0 1 0 0
20	0 0 1 0 1 0 0
21	1 0 1 0 1 0 0
22	0 1 1 0 1 0 0
23	1 1 1 0 1 0 0
24	0 0 0 1 1 0 0
25	1 0 0 1 1 0 0
26	0 1 0 1 1 0 0
27	1 1 0 1 1 0 0
28	0 0 1 1 1 0 0
29	1 0 1 1 1 0 0
30	0 1 1 1 1 0 0
31	1 1 1 1 1 0 0
32	0 0 0 0 0 1 0
33	1 0 0 0 0 1 0

	Switches 1-7 (switch 8 is not used)						
	1 2 3 4 5 6 7						
Address switch position (1= ON, 0=OFF)							
34	0 1 0 0 0 1 0						
35	1 1 0 0 0 1 0						
36	0 0 1 0 0 1 0						
37	1 0 1 0 0 1 0						
38	0 1 1 0 0 1 0						
39	1 1 1 0 0 1 0						
40	0 0 0 1 0 1 0						
41	1 0 0 1 0 1 0						
42	0 1 0 1 0 1 0						
43	1 1 0 1 0 1 0						
44	0 0 1 1 0 1 0						
45	1 0 1 1 0 1 0						
46	0 1 1 1 0 1 0						
47	1 1 1 1 0 1 0						
48	0 0 0 0 1 1 0						
49	1 0 0 0 1 1 0						
50	0 1 0 0 1 1 0						
51	1 1 0 0 1 1 0						
52	0 0 1 0 1 1 0						
53	1 0 1 0 1 1 0						
54	0 1 1 0 1 1 0						
55	1 1 1 0 1 1 0						
56	0 0 0 1 1 1 0						
57	1 0 0 1 1 1 0						
58	0 1 0 1 1 1 0						
59	1 1 0 1 1 1 0						
60	0 0 1 1 1 1 0						
61	1 0 1 1 1 1 0						
62	0 1 1 1 1 1 0						
63	1 1 1 1 1 1 0						
64	0 0 0 0 0 0 1						
65	1 0 0 0 0 0 1						
66	0 1 0 0 0 0 1						
67	1 1 0 0 0 0 1						
68	0 0 1 0 0 0 1						
69	1 0 1 0 0 0 1						
70	0 1 1 0 0 0 1						
71	1 1 1 0 0 0 1						
72	0 0 0 1 0 0 1						
73	1 0 0 1 0 0 1						
74	0 1 0 1 0 0 1						
75	1 1 0 1 0 0 1						
76	0 0 1 1 0 0 1						
77	1 0 1 1 0 0 1						
78	0 1 1 1 0 0 1						
79	1 1 1 1 0 0 1						
80	0 0 0 0 1 0 1						
81	1 0 0 0 1 0 1						
82	0 1 0 0 1 0 1						
83	1 1 0 0 1 0 1						
84	0 0 1 0 1 0 1						
85	1 0 1 0 1 0 1						
86	0 1 1 0 1 0 1						

Switches 1-7 (switch 8 is not used)							
	1	2	3	4	5	6	7
Address switch position (1= ON, 0=OFF)							
87	1	1	1	0	1	0	1
88	0	0	0	1	1	0	1
89	1	0	0	1	1	0	1
90	0	1	0	1	1	0	1
91	1	1	0	1	1	0	1
92	0	0	1	1	1	0	1
93	1	0	1	1	1	0	1
94	0	1	1	1	1	0	1
95	1	1	1	1	1	0	1
96	0	0	0	0	0	1	1
97	1	0	0	0	0	1	1
98	0	1	0	0	0	1	1
99	1	1	0	0	0	1	1
100	0	0	1	0	0	1	1
101	1	0	1	0	0	1	1
102	0	1	1	0	0	1	1
103	1	1	1	0	0	1	1
104	0	0	0	1	0	1	1
105	1	0	0	1	0	1	1
106	0	1	0	1	0	1	1
107	1	1	0	1	0	1	1
108	0	0	1	1	0	1	1
109	1	0	1	1	0	1	1
110	0	1	1	1	0	1	1
111	1	1	1	1	0	1	1
112	0	0	0	0	1	1	1
113	1	0	0	0	1	1	1
114	0	1	0	0	1	1	1
115	1	1	0	0	1	1	1
116	0	0	1	0	1	1	1
117	1	0	1	0	1	1	1
118	0	1	1	0	1	1	1
119	1	1	1	0	1	1	1
120	0	0	0	1	1	1	1
121	1	0	0	1	1	1	1
122	0	1	0	1	1	1	1
123	1	1	0	1	1	1	1
124	0	0	1	1	1	1	1
125	1	0	1	1	1	1	1
126	0	1	1	1	1	1	1
127	1	1	1	1	1	1	1

The PROFIBUS option
card

■ **Timing**

■ **Frequency converter response time behaviour**

The period for the update through the PROFIBUS connection can be subdivided into two portions:

1. The communication period, i.e. the time required to transmit data from the master to the slave (frequency converter with PROFIBUS option), and
2. the internal update period, i.e. the time required to transmit data between the frequency converter control card and the PROFIBUS option card.

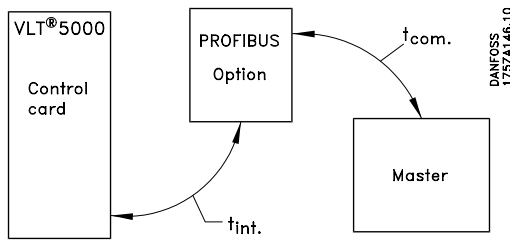

The communication period (t_{com}) depends on the respective transmission speed (baud rate) and the type of master being used. The shortest achievable communication period is approximately 30 msec per slave with the frequency converter PROFIBUS option when DP communication with a data quantity of 4 bytes (PPO type 3) at 12 Mbaud is used. The communication period increases with more data or lower transmission speeds.

The internal update period (t_{int}) depends on the respective data as there are different channels for the transmission of data, with time-critical data, such as the Control word, being given the highest priority. The internal update time for the respective data types is listed below.

Data	Update time, t_{int}
Control word/main reference value (Part of PPO)	2 msec.
Status word/respective output frequency (Part of PPO)	2 msec.
Parameter Read (PCD 1-8)	2 msec.
Parameter Write (PCD 1-2)	40 msec.
Parameter Write (PCD 3-4)	80 msec.
Parameter Write (PCD 5-8)	160 msec.
Parameter Read (PCV)	20 msec.
Parameter Write (PCV)	20 msec.
Acyclical data (read, write)	20 msec.

The update time of a single slave is composed of both the communication period (depending on the baud rate) and the station delay (TSDR) in the slave, and of the delay in the master associated with the station.

The station delay (TSDR) is the delay time from the moment when a station receives the last bit of a telegram to the moment when it sends the first bit of the next telegram. The station delay is defined by two parameters: the minimum station delay ($TSDR_{min}$) and the maximum station delay ($TSDR_{max}$).

Current station delay for the PROFIBUS option:

- DP: 11 bit times

Current master station delay:

- This information must be provided by the manufacturer of the respective PROFIBUS master.

Example

- DP master with 1.5 Mbaud and PPO type 3 (4 byte data); the assumption here is for 50 bit times as master TSDR.

Time [msec]	Action
0	Master starts data transmission
	Last bit received in slave
	Slave station delay
	Slave starts data transmission
	Last bit received in master
	Master station delay (50 bit times » 0.033)
	Master ready for data transmission to next slave

■ **Time behaviour during system update**

The system update period is the time required to update all slaves of the network when cyclical communication is used.

■ Communication connections

Communication pursuant to PROFIBUS DP , i.e. EN50170 part 3, is supported.

Accordingly, a master must be used that supports PROFIBUS DP.

■ PPO description (Overview)

A feature of the PROFIBUS profile for frequency converters is a communications object designated as "PPO", i.e. "parameter process data object".

All cyclical informative data are transmitted via PPOs. Thus, PPOs form the framework for the data traffic. One of the PPOs described in the following must be used in the case of DP communication.

The actual PPO type can be readout in parameter 904.

A PPO may consist of a parameter portion and a process data portion. The parameter portion may be used for reading and/or updating of parameters (successively).

The process data portion consists of a fixed part (4 bytes) and a parameterizable part (8 or 16 bytes). The Control word and speed reference value are transmitted to the frequency converter in the fixed portion, whereas the Status word and current output frequency are transmitted by the frequency converter. In the parameterizable portion, the user selects which parameters are to be transmitted to the frequency converter (parameter 915) and which are to be transmitted by the frequency converter (parameter 916).

PPO, Parameter Process Data Object

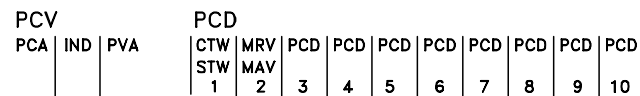

Type 1: Byte String 12

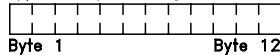

Type 2: Byte String 20

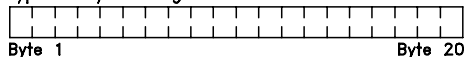

Type 3: Byte String 4

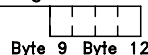

Type 4: Byte String 12

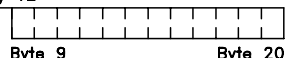

Type 5: Byte String 28

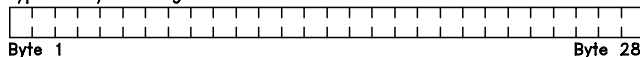

Type 6: Byte String 8

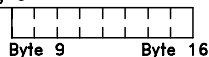

Type 7: Byte String 16

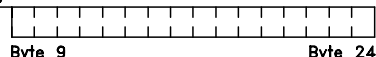

Type 8: Byte String 20

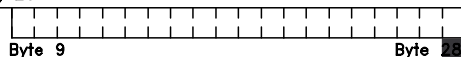

- PDC: Process Data
- PCV: Parameter-Characteristics-Value
- PCA: Parameter-Characteristics (Bytes 1, 2)
PCA handling see section *Examples*
- IND: Subindex (Byte 3)m (Byte 4 is not used)
- PVA: Parameter value (Bytes 5 to 8)
- CTW: Control word
See section *Examples*
- STW: Status word
- MRV: Main reference value
- MAV: Main actual value (Actual output frequency)

185NA2B7.10
PPO description

■ PCA processing

The master controls and monitors frequency converter parameters through the PCA portion of the PPOs type 1, 2 and 5 and requests a response from the frequency converter (slave). In addition to the parameter processing, the frequency converter can also transmit a spontaneous message.

Requests and responses involve an acknowledgement exchange (a so-called handshake) which cannot be worked off in stack operation. This means that the master, when sending a read/write request, must wait for the response before sending a new request. A request or response is limited to a maximum of 4 bytes, i.e. no text strings can be transmitted.

PCA - Parameter description

15	14	13	12	11	10	9	8	7	6	5	4	3	2	1	0
RC				MSP	PNU										

- RC: Request/Response (Sector: 0-15)
Characteristics
- SPM: Toggle bit for spontaneous messages
- PNU: Parameter Number (Sector: 1-990)

Request and response

In the RC portion of the PCA word the requests of the master to the slave are triggered. The other two PCV fields IND and PVA must be evaluated as well.

The PVA portion transmits parameter values in word size with the bytes 7 and 8; double words require the bytes 5-8, i.e. 32 bits.

If the request or response contains array elements, the array subindex will be in IND (byte 3). In the event of a parameter description, IND contains the record subindex.

RC content

Request	Function
0	No request
1	Request parameter value
2	Change parameter value (word)
3	Change parameter value (double word)
4	Request description element
5	Change description element
6	Request parameter value (array)
7	Change parameter value (array word)
8	Change parameter value (array double word)
9	Request number of array elements
10-15	Not assigned

Re- sponse	Function
0	No response
1	Transmit parameter value (word)
2	Transmit parameter value (double word)
3	Transmit description element
4	Transmit parameter value (array word)
5	Transmit parameter value (array double word)
6	Transmit number of array elements
7	Request not executable (with error number, see below)
8	No operating authority for PCV interface
9	Spontaneous message (word)
10	Spontaneous message (double word)
11	Spontaneous message (array word)
12	Spontaneous message (array double word)
13-15	Not assigned

If a request from the master is not executed by the slave, the RC word in the PPO-Read has the value 7. The error number is in bytes 7 and 8 of the PVA element.

Error no. Meaning

0	
1	Parameter value not changeable
2	Upper or lower value passed
3	Faulty subindex
4	No array
5	Wrong data type
6	Setting not permitted (resettable only)
7	Description element not changeable
8	No PPO-Write for IR
9	Description data not available
10	Access group
11	No parameter operating authority
12	Keyword missing
13	Text not readable in cyclical traffic
14	Name not readable in cyclical traffic
15	Text array not available
16	PPO-Write missing
17	Request temporarily unexecutable
18	Other error
19	Data not readable in cyclical traffic

■ Parameters and data type structures

■ Parameter description

Parameters which are accessible through the parameter number (PNU) have additional attributes that are a component of the accompanying descriptive element. Writing/reading of a parameter description occurs through the PCV portion by means of the RC commands 4/5 and the subindex of the desired descriptive element (see accompanying diagram).

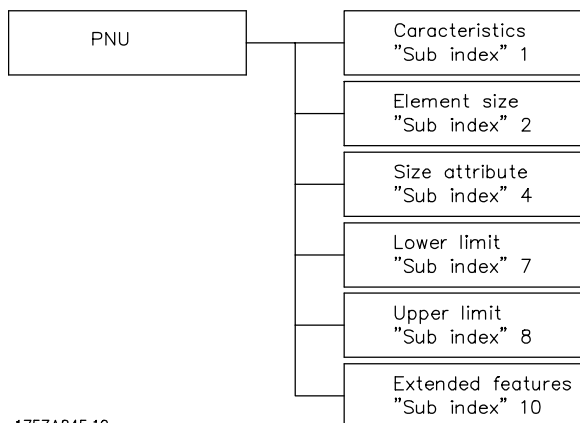

175ZA845.10

Characteristics

The "characteristics" subindex extends the definition of the parameter description. The individual bits 9 to 15 have the values TRUE [1] or FALSE [0] (see table below).

Bit	Meaning
15	Active parameter
14	Array
13	Parameter value resettable only
12	Factory setting of parameter changed
11	Text available
10	Additional text array available
9	No write access (read only)
8	Lower and upper limit. Standardization and size attribute not relevant.
0-7	Data type of the parameter corresponds to OD

The low byte (bit 0-7) indicates the data type of the parameter (see following table).



NB!:

The "data type" for each parameter can be found in the corresponding column in the chapter parameter listing.

Data types supported by the frequency converter

Data type	Object	Short form	Description
3	5	12	Integer 16
4	5	12	Integer 32
5	5		Unsigned 8
6	5	02	Unsigned 16
7	5	04	Unsigned 32
9	5		Visible string
10	5		Byte string
33	5	N2	Standardization value (16 bit) ¹⁾
35	5	V2	Bit sequence

1) See following page for details

Example: Data type 5 = Unsigned 8

Size attribute

The size attribute is 2 bytes long.

Byte 1 incorporates the physical unit of measurement (size index), byte 2 the conversion index .



NB!:

The "conversion index" for each parameter can be found in the corresponding column in the chapter parameter listing.

The "conversion index" produces the conversion factor for each parameter.

Example:

Parameter 205: Conversion index = -3 <=> (10E-3)
Conversion factor: 0.001
15200 = 15.200 Hz

An exception from the PROFIDRIVE profile with respect to the assignment of the size index and the conversion index to the physical size can be found on the following page.

Standardized value

A linear value 0% = 0 (0h), 100% are 214 (4000h)

Data type	N 2
Range	-200% ... 200% - 2 ⁻¹⁴
Resolution	2 ⁻¹⁴ = 0,0061%
Length	2 bytes

Note: Two's complement notation

MSB is the first bit after the sign bit of the first byte.

Sign bit = 0 = positive number

Sign bit = 1 = negative number

**VLT® 5000/ 5000 FLUX/ 6000 HVAC/
8000 AQUA PROFIBUS**

Bit	8	7	6	5	4	3	2	1
Byte	SIGN	2 ¹⁴	2 ¹³	2 ¹²	2 ¹¹	2 ¹⁰	2 ⁹	2 ⁸
2								
Byte	2 ⁷	2 ⁶	2 ⁵	2 ⁴	2 ³	2 ²	2 ¹	2 ⁰
1								

Physical size	Size index	Unit of measurement	Abbreviation	Conversion index	Conversion factor
	0	No dimension		0	1
Time		Second	s	0	1
				-1	0.1
				-2	0.01
	4	Millisecond	ms	-3	0.001
		Minute	min	70	60
		Hour	h	74	3600
		Day	d	77	86400
Energy		Watt-hour	Wh	0	1
	8	Kilowatt-hour	kWh	3	1000
		Megawatt-hour	MWh	6	10
Power		Milliwatt	mW	-3	0.001
	9	Watt	W	0	1
		Kilowatt	kW	3	1000
		Megawatt	MW	6	10
Rotation	11	Revolutions per minute	RPM	0	1
Torque		Newtonmeter	Nm	0	1
	16	Kilonewton-meter	kNm	3	1000
Temperature	17	Degree Celsius	°C	0	1
Voltage		Millivolt	mV	-3	0.001
	21	Volt	V	0	1
		Kilovolt	kV	3	1000
Current		Milliampere	mA	-3	0.001
	22	Ampere	A	0	1
		Kiloampere	kA	3	1000
Resistance		Milliohm	mOhm	-3	0.001
	23	Ohm	Ohm	0	1
		Kiloohm	kOhm	3	1000
Relation	24	Percent	%	0	1
Relative change	27	Percent	%	0	1
Frequency		Hertz	Hz	0	1
	28	Kilohertz	kHz	3	1000
		Megahertz	MHz	6	10

■ **Spontaneous messages**

The spontaneous message is triggered by the active alarm and warning words parameters in the actual drive. The PCV response indicates the parameter number (PNU) and the parameter value (PVA) of the modified active parameter that triggered the message.

Spontaneous messages are generated when active parameters are changed, i.e. a message occurs when a warning appears and when a warning disappears.

At the same time, the frequency converter modifies the SPM bit (11) of the PCV word (see "PCA processing").

Example of a spontaneous message for VLT 5000

Observation of the parameter channel (PCV) from the PPO (without index field):

PCV (Hex)	PVA (Hex)	from Master	from frequency converter	Description
12 08	00 00 00 00	x		The master requests the current of the frequency converter
12 08	00 00 00 F0		x	The frequency converter current value: 2.4 Amp (parameter 520)
12 08	00 00 00 00	x		The master requests the current of the frequency converter
AC 1A	00 00 00 0A		x	The frequency converter has a spontaneous message, the spontaneous message bit is set, the PNU 538 (alarm word) has the value 000A (Hex)
1C 08	00 00 00 00	x		The master requests the current of the frequency converter and acknowledges the spontaneous message by "toggling" the SPM in the PCV
1C 08	00 00 00 F0		x	The frequency converter current value: 2.4 Amp, the spontaneous message bit remains at "1" until the next spontaneous message; the spontaneous message is acknowledged.



NB!:

Spontaneous messages are only activated when the parameter 917 is in the "ON" position. In the event of an activated spontaneous message, the parameter channel is blocked until the spontaneous message has been acknowledged by the master.

Spontaneous messages

The frequency converter saves up to 16 consecutively transmitted SPMs in a FIFO buffer. If only one SPM is in the FIFO buffer, the frequency converter immediately resumes normal operations after the master has acknowledged it (and the cause of the SPM has been eliminated). If there is more than one SPM in the FIFO buffer, the transmission takes place one after the other following the acknowledgement. Additional SPMs that are generated while the buffer is full will be ignored.

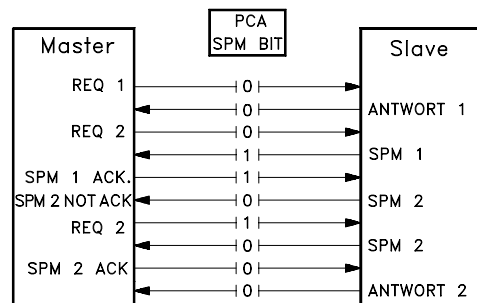

DANFOSS
AT17502444.10

■ **SYNC and FREEZE**

The control commands SYNC/UNSYNC (SYNCHRONIZE/CANCEL SYNCHRONIZATION) and FREEZE/UNFREEZE are broadcast functions. SYNC/UNSYNC is used to transmit synchronized control commands and/or speed reference values to all connected slaves. FREEZE/UNFREEZE is used to freeze the status actual value in the slaves in order to receive a synchronized actual value from all connected slaves.

The SYNC and FREEZE commands refer to the PCD and PCV portions of the PPO.

■ **SYNC/UNSYNC**

By using SYNC/UNSYNC, simultaneous responses of several slaves can be generated, e.g. synchronized start, stop, or change of the speed. In the event of a SYNC command, the current Control word and the speed reference value are frozen. Incoming process data are saved, but are only applied when a new SYNC command or an UNSYNC command is made.

The following example shows the speed reference value sent by the master in the left column and the respective effective speed reference value for the three slaves in the three columns to the right.

From DP master to address:	Current speed reference value slave		
	VLT Address 3	VLT Address 4	VLT Address 5
1. Speed reference value = 50% to address 3 ⇒	50%	0 %	0 %
2. Speed reference value = 50% to address 4 ⇒	50%	50%	0 %
3. Speed reference value = 50% to address 5 ⇒	50%	50%	50%
4. SYNC command to all addresses ⇒	50%	50%	50%
5. Speed reference value = 75% to address 3 ⇒	50%	50%	50%
6. Speed reference value = 75% to address 4 ⇒	50%	50%	50%
7. Speed reference value = 75% to address 5 ⇒	50%	50%	50%
8. SYNC command to all addresses ⇒	75 %	75 %	75 %
9. Speed reference value = 100% to address 3 ⇒	75 %	75 %	75 %
10. Speed reference value = 50% to address 4 ⇒	75 %	75 %	75 %
11. Speed reference value = 25% to address 5 ⇒	75 %	75 %	75 %
12. UNSYNC command to all addresses ⇒	100 %	50 %	25 %
13. Speed reference = 0% to address 3 ⇒	0 %	50 %	25 %
14. Speed reference = 0% to address 4 ⇒	0 %	0 %	25 %
15. Speed reference = 0% to address 5 ⇒	0 %	0 %	0 %

■ **FREEZE/UNFREEZE**

By using FREEZE/UNFREEZE, simultaneous reading of process data, e.g. output current, by several slaves can be brought about. At a FREEZE command, the actual current values are frozen. When instructed, the slave will send back the value in effect at the time the FREEZE command was issued. The respective

values are updated when a new FREEZE command or an UNFREEZE command is issued.

The following example shows the current values read by the master in the left column and the respective effective value of the output current for the three slaves in the three columns to the right.

DP master reads address:	Actual output current slave		
	VLT Address 3	VLT Address 4	VLT Address 5
1. Address 3 output current = 2 A ⇐	2 A	3 A	4 A
2. Address 4 output current = 5 A ⇐	2 A	5 A	2 A
3. Address 5 output current = 3 A ⇐	3 A	2 A	3 A
4. FREEZE command to all addresses ⇒	1 A	3 A	3 A
5. Address 3 output current = 1 A ⇐	4 A	2 A	5 A
6. Address 4 output current = 3 A ⇐	2 A	2 A	2 A
7. Address 5 output current = 3 A ⇐	3 A	1 A	2 A
8. UNFREEZE command to all addresses ⇒	2A	3 A	4 A

Readout same as for 1, 2 and 3

Bit 04, Quick stop/Ramp

Quick stop using the ramp time of parameter 212. In the case of bit 04 = "0", a quick stop occurs. In the case of bit 04 = "1", the frequency converter can start if the other start conditions are satisfied. Note: The selection in parameter 503 determines how bit 04 is linked with the corresponding function of the digital inputs.

Bit 05, Save output frequency/Ramp possible

In the case of bit 05 = "0", the current output frequency is being maintained even if the reference value is modified. In the case of bit 05 = "1", the frequency converter can perform its regulating function again; operation occurs according to the respective reference value.

Bit 06, Ramp stop/Start

Normal ramp stop using the ramp times of the parameters 207/208 or 209/210. In addition, activation of the output relay 01 or 04 if the output frequency is 0 Hz if Relay 123 has been selected in parameter 323 or 326. Bit 06 = "0" leads to a stop. In the case of bit 06 = "1", the frequency converter can start if the other start conditions are satisfied. Note: The selection in parameter 505 determines how bit 06 is linked with the corresponding function of the digital inputs.

Bit 07, Without function/Reset

Reset after switching off. In the case of bit 07 = "0", no reset occurs. In the case of a slope change of bit 07 to "1", a reset occurs after switching off.

Bit 08, Fixed speed 1 OFF/ON

Activation of the preprogrammed speed in parameter 509 (bus JOG 1). JOG 1 is only possible if bit 04 = "0" and bit 00 - 03 = "1".

Bit 09, Fixed speed 2 OFF/ON

Activation of the preprogrammed speed in parameter 510 (bus JOG 2). JOG 2 is only possible if bit 04 = "0" and bit 00 - 03 = "1". If both JOG 1 and JOG 2 are activated (bit 08 and 09 = "1"), then JOG 1 has the higher priority, i.e. the speed programmed in parameter 509 will be used.

Bit 10, Data not valid/valid

Is used to notify the VLT5000 series whether the process data channel (PCD) should respond to modifications by the master (bit 10 = 1) or not. The function can be inverted in parameter 805.



NB!:

In the case of bit 10 = 0, the VLT does not respond to the Control word or the main reference value.

Bit 11, Without function/Frequency correction DOWN

Is used to reduce the speed reference value by the amount given in parameter 219. In the case of bit 11 = "0", no modification of the reference value occurs. In the case of bit 11 = "1", the reference value is reduced.

Bit 12, Without function/Frequency correction UP

Is used to increase the speed reference value by the amount given in parameter 219. In the case of bit 12 = "0", no modification of the reference value occurs. In the case of bit 12 = "1", the reference value is increased. If both - slowing down and accelerating - are activated (bit 11 and 12 = "1"), slowing down has priority, i.e. the speed reference value will be reduced.

Bit 13/14, Setup selection

Bit 13 and 14 are used to choose between the four parameter setups according to the following table:

Setup	Bit 14	Bit 13
1	0	0
2	0	1
3	1	0
4	1	1

The function is only possible if *External Selection* has been chosen in parameter 004.

The selection in parameter 507 determines how bit 13/14 is linked with the corresponding function of the digital inputs.

Bit 15, Without function/Reversion

Reversion of the rotational direction of the motor. In the case of bit 15 = "0", no reversion occurs. In the case of bit 15 = "1", a reversion takes place. Please note that the reversion in the factory setting in parameter 506 has been selected as "terminal". Bit 15 only causes a reversion if bus, bus or terminal or bus and terminal has been selected (bus and terminal only in connection with terminal 9, however).



NB!:

Unless otherwise indicated, the bit of the Control word is linked with the corresponding function of the digital inputs as a logical "or" function.

■ Status word according to profdriveprofile

The Status word is used to notify a master (e.g. a PC) about the status of a slave.

In the case of bit 03 = "1", the frequency converter has tripped and requires a reset signal before it can start.

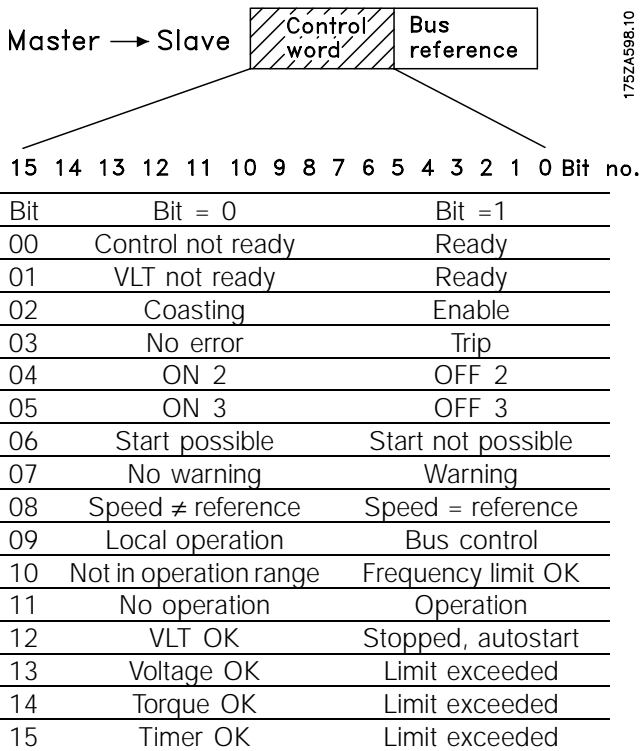

175ZA998.10

Control word/Status word

Bit 00, Control not ready/ready

In the case of bit 00 = "0", bit 00, 01 or 02 of the Control word is "0" (OFF 1, OFF 2 or OFF 3) - or the frequency converter has switched off (trip). In the case of bit 00 = "1", the frequency converter control is ready, but there is not necessarily a supply to the power unit present (in the case of external 24 V supply of the control system).

Bit 01, VLT not ready/ready

Same significance as bit 00, however, there is a supply of the power unit. The frequency converter is ready when it receives the necessary start signals.

Bit 02, Coasting/Enable

In the case of bit 02 = "0", bit 00, 01 or 02 of the Control word is "0" (OFF 1, OFF 2 or OFF 3 or coasting) - or the frequency converter has switched off (trip). In the case of bit 02 = "1", bit 00, 01 or 02 of the Control word is "1"; the frequency converter has not tripped.

Bit 03, No error/Trip

In the case of bit 03 = "0", no error condition of the frequency converter exists.

Bit 04, ON 2/OFF 2

In the case of bit 04 = "0", bit 01 of the Control word is "1"

In the case of bit 04 = "1", bit 01 of the Control word is "0".

Bit 05, ON 3/OFF 3

In the case of bit 05 = "0", bit 02 of the Control word is "1"

In the case of bit 05 = "1", bit 02 of the Control word is "0".

Bit 06, Start possible/Start not possible

Bit 06 is always "0" if FC Drive has been selected in parameter 512. If Profdrive has been selected in parameter 512, bit 06 will be "1" after a switch-off acknowledgement, after activation of OFF2 or OFF3, and after switching on the mains voltage. Start not possible will be reset, with bit 00 of the Control word being set to "0" and bit 01, 02 and 10 being set to "1".

Bit 07, No warning/Warning

In the case of bit 07 = "0", no unusual situation exists.

In the case of bit 07 = "1", an unusual status of the frequency converter has occurred. All warnings are described in the operations manual.

Bit 08, Speed ≠ reference / Speed = reference:

In the case of bit 08 = "0", the current speed of the motor deviates from the set speed reference value. This may occur, for example, when the speed is being changed during start/stop through ramp up/down. In the case of bit 08 = "1", the current speed of the motor corresponds to the set speed reference value.

Bit 09, Local operation/Bus control

Bit 09 = "0" indicates that the frequency converter has been stopped by means of the stop switch of the control panel, or that Local has been selected in parameter 002. In the case of bit 09 = "1", the frequency converter can be controlled through the serial interface.

Bit 10, Not in operating range/Frequency limit OK

In the case of bit 10 = "0", the output frequency is outside the limits set in parameter 225 and parameter 226 (Warnings: frequency low or frequency high). In the case of bit 10 = "1", the output frequency is within the indicated limits.

Bit 11, No operation/Operation

In the case of bit 11 = "0", the motor does not turn. In the case of bit 11 = "1", the frequency converter has a start signal, or the output frequency is higher than 0 Hz.

Bit 12, VLT OK/Stopped, autostart

In the case of bit 12 = "0", there is no temporary overloading of the inverter.

In the case of bit 12 = "1", the inverter has stopped due to overloading. However, the frequency converter has not switched off (trip) and will start again after the overloading has ended.

Bit 13, Voltage OK/Limit exceeded

In the case of bit 13 = "0", the voltage limits of the frequency converter are not exceeded.

In the case of bit 13 = "1", the direct voltage in the intermediate circuit of the frequency converter is too low or too high.

Bit 14, Moment OK/Limit exceeded

In the case of bit 14 = "0", the motor current is below the moment limit selected in parameter 221.

In the case of bit 14 = "1", the moment limit selected in parameter 221 is exceeded.

Bit 15, Timer OK/Limit exceeded

In the case of bit 15 = "0", the timers for the thermal motor protection and thermal frequency converter protection have not exceeded 100%. In the case of bit 15 = "1", one of the timers has exceeded 100%.

■ Control word according to fc standard

Control word in FC profile (parameter 512 = FC Drive)

The Control word is used to send commands from a master (e.g. a PC) to a slave.

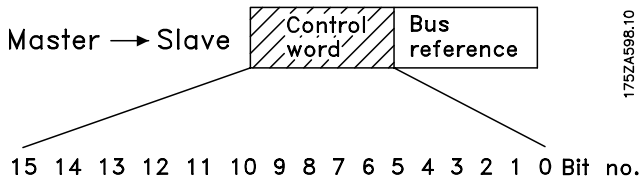

Bit	Bit = 0	Bit = 1
00	Reference value external selection lsb	
01	Reference value external selection msb	
02	DC brake	Ramp
03	Freewheel	No freewheel
04	Quick stop	Ramp
05	Holding	Ramp possible
06	Ramp stop	Start
07	Without function	Reset
08	Without function	Jog
09	Ramp 1	Ramp 2
10	Data not valid	Valid
11	Without function	Relay 01 active
12	Without function	Relay 04 active
13	Parameter setup selection lsb	
14	Parameter setup selection msb	
15	Without function	Reversion

Bit 00/01

The bits 00 and 01 are used to choose between the four preprogrammed reference values (parameters 215-218) according to the following table:

Progr. ref. val.	Parameter	Bit 01	Bit 02
1	215	0	0
2	216	0	1
3	217	1	0
4	218	1	1

Bit 02, DC brake

Bit 02 = "0" leads to direct voltage braking and stop. Braking current and duration are set in parameter 125 and 126.

Bit 02 = "1" results in *Ramp*.

Bit 08, Activation of the fixed speed in parameter 213

In the case of bit 08 = "0", the fixed speed will not be activated.

In the case of bit 08 = "1", the motor runs at the fixed speed.

Bit 09, Ramp selection 1/2

In the case of bit 09 = "0", ramp 1 is active (parameter 207/208).

In the case of bit 09 = "1", ramp 2 is active (parameter 209/210).

Bit 11, Relay 01

Bit 11 = "0": Relay 01 is not activated.

Bit 11 = "1": Relay 01 is activated, on the pre-condition that Control word bit was selected in parameter 323.

Bit 12, Relay 04

Bit 12 = "0": Relay 04 is not activated.

Bit 12 = "1": Relay 04 is activated, on the pre-condition that Control word bit was selected in parameter 326.



NB!

The description of the other bits can be found in the section "Control word according to Profidrive".

■ **Status word according to fc standard**

The Status word is used to notify a master (e.g. a PC) about the status of a slave.

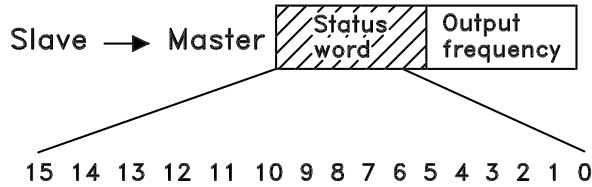

Bit	Bit = 0	Bit =1
00	Control not ready	Ready
01	VLT not ready	Ready
02	Coasting	Enable
03	No error	Trip
04	Not in use	
05	Not in use	
06	Not in use	
07	No warning	Warning
08	Speed ≠ref.	Speed = ref.
09	Local operation	Bus control
10	Not in operation	Frequency limit OK range
11	No operation	Operation
12	VLT OK	Stopped, autostart
13	Voltage OK	Limit exceeded
14	Torque OK	Limit exceeded
15	Timer OK	Limit exceeded

Bit 00, Control not ready/ready:

Bit 00 = "0" means that the frequency converter has switched off due to malfunction.

Bit 00 = "1" means that the frequency converter control is ready, but that there is not necessarily a supply to the power unit present (in the case of external 24 V supply of the control card).

Bit 02, Coasting/Enable

Bit 02 = "0" means that the bit 03 of the Control word is "0" (Coasting) or that the frequency converter has tripped.

Bit 02 = "1" means that the bit 03 of the Control word is "1" and that the frequency converter has not tripped.



NB!:

The description of the other bits can be found in the section "Status word according to Profidrive".

■ Bus reference value

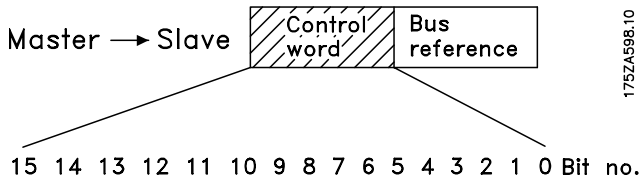

The frequency reference value is transmitted to the frequency converter in the form of a 16-bit word. The value is transmitted in integers (0-32767). 16384 (4000 Hex) corresponds to 100%. (Negative numbers are formed with the aid of the two's complement.)

The bus reference value has the following format: Parameter 203 = "0"

$$0-16384 \text{ (4000 Hex)} \sim 0-100\% \sim \text{ref}_{\text{MIN}} - \text{ref}_{\text{MAX}}$$

Parameter 203 = "1"

$$-16384 \text{ (. . . Hex)} - + 16384 \text{ (4000 Hex)} \sim -100 - + 100\% \sim -\text{ref}_{\text{MIN}} - +\text{ref}_{\text{MAX}}$$

Current output frequency

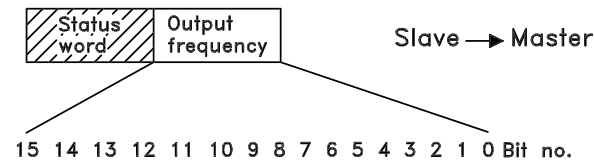

The value of the current output frequency of the frequency converter is transmitted in the form of a 16-bit word. The value is transmitted in integers (0-32767). 16384 (4000 Hex) corresponds to 100%. (Negative numbers are formed with the aid of the two's complement.)

Bus reference value

■ **Example 1: PCV Channel**

This example shows how PPO type 1 is used for changing the ramp-up time (parameter 207) to 10 seconds and for commanding a start and speed reference of 50%.

- PCD: Process Data
- PCV: Parameter-Characteristics Value
- PCA: Parameter-Characteristics (Bytes 1. 2)
PCA handling below
- IND: Subindex (Byte 3), (Byte 4 is not used)

In the configuration of the PPO types (informative data telegrams), a distinction is made between module consistency and word consistency:

Module consistency means that a particular portion of the PPO is defined as a connected module. The parameter interface (PCV, length 8 byte) of the PPO always has module consistency.

Word consistency means that a particular portion of the PPO is divided into individual data sectors of word size (16 bit).

Frequency converter parameter settings:

P502: serial port

P512: Fieldbus profile (Profidrive profile) = factory setting

Please see section *PPO description*.

- PVA: Parameter value (Bytes 5 to 8)
- CTW: Control word
- STW: Status word
- MRV: Main reference value
- MAV: Main actual value

The process data (PCD) of the PPO can have either module consistency or word consistency, as desired.

Some PLCs, such as the Siemens S7, require special functions to address modules that are longer than 4 byte (in the case of Siemens: "SFC", see Master Manual). This means that, in the case of Siemens (S7), the PCV interface of the PPOs can only be addressed through the SFC functions.

PCV

PCA Parameter characteristics

- RC: Request/Response (Range: 0-15)
- SPM: Toggle bit for spontaneous messages
- PNU: Parameter Number (Range: 1-990)

PCA portion (byte 1-2)

The RC portion determines what the PCV portion is to be used for. If a parameter needs to be changed, value 2 or 3 must be selected; here, 3 was selected since parameter 207 refers to a double word (32 bits).

SPM bit

In the example, the function "spontaneous messages" is not needed (parameter 917 = OFF) and thus the SPM bit is set to 0.

PNU = Parameter Number The parameter number is set to: 207 = CF Hex. This means that the value for the entire PCA portion is 30CF Hex.

IND (bytes 3-4)

This is used in reading/changing of parameters with subindex, e.g. in the case of parameter 915. In the example, the bytes 3 and 4 are set to 00Hex.

PVA (bytes 5-8)

Changing the data value of parameter 207 to 10.00 s. The transmitted value must be 1000, since the conversion index for parameter 207 is -2, i.e. the value received by the frequency converter is divided by 100 so that the frequency converter "understands" 1000 as 10.00. 1000 corresponds to 03E8Hex.

PCD (Process Data)

CTW (Control Word)

The following bit patterns set all necessary start commands:

150 <=> Bit number
0 000 0100 0111 111 1 <=> 047FHex.

MRV (Main Reference Value)

Speed reference value, the data format is "standardized value".

0Hex = 0% and 4000Hex = 100%.

For example, 2000Hex correspond to 50% of the maximum frequency (parameter 202).

The entire PPO being sent from the master to the frequency converter thus has the following hexadecimal values:

		Byte	Value
PCV	PCA	1 and 2	30CF
	IND	3 and 4	0000
	PVA	5 and 6	0000
	PVA	7 and 8	03E8
PCD	CTW	9 and 10	047F
	MRV	11 and 12	2000

The process data within the PCD portion have a direct effect on the frequency converter and can be updated by the master in the quickest possible way.

The PCV portion is a process with an exchange of acknowledgements (so-called handshake), i.e. the frequency converter must confirm the command before a new one can be written.

A positive response of the frequency converter to the above example might look like this:

		Byte	Value
PCV	PCA	1 and 2	20CF
	IND	3 and 4	0000
	PVA	5 and 6	0000
	PVA	7 and 8	03E8
PCD	STW	9 and 10	0F07
	MAV	11 and 12	2000

The response of the PCD portion depends on the status and the parameterization of the frequency converter.

The PCV portion responds as follows:

PCA

like the request telegram, but with the RC portion assuming the characteristics for "transmit double word" (HEX 2 for the RC portion).

IND

is not used in this example.

PVA

03E8Hex in the low-byte of the PVA portion indicates that the value of the parameter in question (207) is 1000, which corresponds to 10.00. The high-byte portion of the PVA is HEX 0000.

STW

0F07Hex means that the motor is running and that no warnings or errors are present (further details can be found in the status word table).

MAV

2000Hex indicates that the output frequency is 50% of the maximum frequency.

A negative response of the frequency converter might look like this:

		Byte	Value
PCV	PCA	1 and 2	70CF
	IND	3 and 4	0000
	PVA	5 and 6	0000
	PVA	7 and 8	0002
PCD	STW	9 and 10	0F07
	MAV	11 and 12	2000

RC is HEX 7 which means that the request is not executable. The corresponding error number is in the low-byte portion of the PVA.

In this case, the error number 2 means that the upper or lower warning limit of the parameter has been passed (see table of error numbers in "PCA processing").

Example 2: Process data from the frequency converter

Example for filling the variable process data in PPO 4, please see section *PPO description*.

Assumption: the frequency converter is operating as in the previous example. At the same time, the motor current (PCD1), the status of the digital inputs (PCD2), the frequency value in Hz (PCD3), and the voltage at terminal 53 (PCD4) are to be indicated.

Fixing the process data on the display unit

The process data from the frequency converter are read. Therefore, the parameter 916 (PCD-Read) must be used for the configuration of the PCD.

- a. The parameter number for displaying the motor current is entered on the display unit of the frequency converter under the index number <1>: 520.
- b. The parameter number for displaying the digital inputs is entered under the index number <2>: 528.
- c. Index number <3> = 518 (display of the frequency)
- d. Index number <4> = 529 (display of the voltage at input 53)

Frequency converter response PPO type 4

For example, the frequency converter response of a PPO 4 telegram after the configuration might look like this:

		Byte	Value (Hex)
PCV	STW	1 and 2	0F07
	MAV	3 and 4	2000
	PCD1	5 and 6	00F6
	PCD2	7 and 8	0028
	PCD3	9 and 10	00FA
	PCD4	11 and 12	02F8

VLT® 5000/ 5000 FLUX/ 6000 HVAC/ 8000 AQUA PROFIBUS

STW

0F07Hex means that the motor is running and that no warnings or errors are present (further details can be found in the status word table).

MAV

2000Hex indicates that the output frequency is 50% of the maximum frequency.

PCD1

HEX F6 = 246 decimal. The conversion index for parameter 520 is -2, i.e. the value must be divided by 100. Thus, the present motor current is: 2.46 A

PCD2

Hex 28 = 0010 1000 binary. The allocation of the digits: (digital inputs of the frequency converter)

This means that input 18 and input 27 of the frequency converter are switched.

PCD3

Hex FA = 250 decimal. The conversion index for parameter 518 is -1, i.e. the value must be divided by 10. Thus, the instantaneous frequency is 25.0 Hz.

PCD4

Hex 2F8 = 760 decimal. The conversion index for parameter 529 is -2, i.e. the value must be divided by 100. Thus, the instantaneous voltage at terminal 53 of the frequency converter is: 7.60 Volt.



NB!:

Information concerning the conversion index for each parameter can be found in the parameter list.

The explanation of the column headings for the parameter table can be found in the section "Parameter and data structures" (keyword: size attribute).

■ Example 3: Array treatment

Example for addressing an array parameter. Assumption: as in the previous examples, the frequency converter is running. Now, the variable process data are not to be preconfigured on the display, but are to be configured through the PCV portion (of the PPO2) instead. For example, only the PCD 1 will be configured for the display of the motor current.

Master telegram (PPO2)

The master sends the following telegram to the frequency converter:

	Byte	Value (Hex)
PCV	PCA	1 and 2 7394
	IND	3 and 4 0100
	PVA	5 and 6 0000
	PVA	7 and 8 0208
	CTW	9 and 10 047F
	MRV	11 and 12 2000
	PCD1	13 and 14 0000
	PCD2	15 and 16 0000
	PCD3	17 and 18 0000
	PCD4	19 and 20 0000

PCA

Hex 7 corresponds to "change parameter value (array word)" in the RC portion of the PCA.

Hex 394 = 916 decimal.

The parameter 916 is used to configure the PCD-Read. Since a subindex is required to configure the parameter, the parameter 916 is an array.

IND

Hex 01 in byte 3 is used for the assignment to PCD 1. The byte 4 is not used and is thus filled with Hex 00 by the master.

PVA

In the high portion of the PVA is Hex 0000. In the low portion of the PVA is Hex 0208 = 520 decimal. The parameter number for the display of the of the motor current is thus assigned to the PCD 1.

CTW and MRV

For an explanation of the Control word and of the main reference value see example 1.

PCD 1 to 4

Since PPO 2 is used, PCD1-4 must be transmitted by the master (filled with zeros as the PCD-Write are not defined).

VLT response telegram (PPO2)

The frequency converter might send back the following telegram to the master:

	Byte	Value (Hex)
PCV	PCA	1 and 2 4394
	IND	3 and 4 0100
	PVA	5 and 6 0000
	PVA	7 and 8 0208
	STW	9 and 10 0F07
	MAV	11 and 12 2000
	PCD1	13 and 14 00F6
	PCD2	15 and 16 0000
	PCD3	17 and 18 0000
	PCD4	19 and 20 0000

PCA

Hex 4 corresponds to "transmit parameter value (array word)" in the RC portion of the PCA. Hex 394 = 916 decimal. The frequency converter repeats the parameter number sent by the master (for handshake control).

IND

The frequency converter repeats the subindex sent by the master (for handshake control).

PVA (high word and low word)

The frequency converter repeats the parameter number sent by the master (for handshake control).

STW and MAV

For an explanation of the Status word and of the main actual value see example 1.

PCD1

HEX F6 = 246 decimal. The conversion index for parameter 520 is -2, i.e. the value must be divided by 100. Thus, the present motor current is: 2.46 A

PCD2 to PCD4

Since the PCD in this example are not configured yet, the frequency converter will fill the individual PCD with Hex 0000.

**NB!:**

Please note that modified parameters are only saved permanently (protected against the event of a mains failure) in the EEPROM of the frequency converter if parameter 971 is activated after the parameter modification. This is not done in the example, i.e. the configuration of the PCD data is lost after switching the mains current off/on.

**VLT® 5000/ 5000 FLUX/ 6000 HVAC/
8000 AQUA PROFIBUS**

■ **DP V1 Identifications**

The V1 functionalities require a GSD file supporting V1. Of compatibility reasons in general the V1 versions got the same DP ident number as the corresponding V0 version. This means, that a V1 unit can replace

a V0 unit without changing the master configuration. The table shows the available GSD files for VLT 5000/5000 FLUX/6000 HVAC/8000 AQUA. GSD files are placed on <http://www.danfoss.com/drives>.

GSD File Name	Description	Ident nr.	GSD Revision
VLT 5000			
VLT 6000 HVAC			
VLT 8000 AQUA			
DA030402.GSD	(actual version) V0	0402	03
DA040402.GSD	(actual version) V1	0402	04

■ VLT frequency converter parameters

Only the parameter groups (800 and 900) specific to the profibus are described in this manual. For any other parameters of the VLT 5000 series/VLT 5000 Flux, VLT 6000 HVAC/VLT 8000 AQUA and their functions, please refer to the VLT 5000/5000 Flux/6000 HVAC/8000 AQUA series operations manual.



NB!:

Please pay special attention to the following parameters which are not described in this manual:

- 002: In the case of local operation, a control via PROFIBUS is not possible.
- 502-508: Selection of how the PROFIBUS control commands are to be linked with the control commands of the digital inputs of the control card.
- 512: Control word profile, selection of a Control word according to FIELDBUS or according to a Control word specified by Danfoss.
- 515-538: Data output parameters which can be used for the display of a variety of current data of the frequency converter, e.g. current status of the analog and digital inputs of the control card and, therefore, their usage as inputs for the master.

**800 Protocol selection
(PROTOCOL SELECT)**

Value:
Read only

Function:
Selection of the PROFIBUS protocol supported by the master

Description of choice:
DP: Communication according to EN 50170, part 3



NB!:

In the event of an update of parameter 800, from LCP or FC bus even with an unchanged data value, the PROFIBUS option is initialized, which means that all communication parameters, e.g. slave address, are being updated. The communication is being reset and the previous changed address parameter 918 will be valid.

**803 Time after bus error
(BUS TIME OUT)**

Value:
1 - 99 sec. ★ 1 sec.

**804 Response after bus error
(TIME OUT FUNCT.)**

Value:

★Off (OFF)	[0]
Freeze output frequency (FREEZE OUTPUT)	[1]
Stop with auto restart (STOP)	[2]
Output frequency = JOG frequency (JOGGING)	[3]
Output freq. = Max. freq. (MAX SPEED)	[4]
Stop with trip (STOP AND TRIP)	[5]
Control without PROFIBUS (NO COM OPT CONTROL)	[6]
Select setup 4 (SELECT SETUP 4)	[7]
Select setup 2 (SELECT SETUP 2)	[8]

Function:

The timeout counter is activated at the first receipt of a valid Control word, i.e. bit 10 = OK. In case of an acyclic DP V1 communication the timeout function will not be triggered.

The Timeout function can be activated in two ways:

1. CTW is not updated within the specified time.
2. Parameter 805 = "Bit 10 = 0 Timeout" and bit 10 = "0".

The frequency converter remains in the timeout status until one of the following four conditions occurs.

1. A valid Control word (bit 10 = OK) is received and a reset (bus, terminals or control panel) is activated (reset is only necessary if the timeout function Stop with trip was selected) ⇒ control via PROFIBUS is resumed with the current Control word.
2. Parameter 002 = Local operation ⇒ local control through control panel is active.
3. Parameter 928 = Not active ⇒ normal control through terminals and RS 485 is active.



NB!:

The timeout counter is reset and needs to be triggered by a valid Control word before a new timeout can be activated.

4. Parameter 804 = Off ⇒ control via PROFIBUS is resumed, with the Control word used last being taken.

Description of choice:

- Save output frequency: Save ('freeze') the output frequency until communication resumes.

Parameters

VLT® 5000/ 5000 FLUX/ 6000 HVAC/ 8000 AQUA PROFIBUS

- *Stop with auto restart*: Stop with automatic restart on resumption of communication.
- *Output frequency = Fixed speed frequency*: Motor runs with fixed speed frequency until resumption of communication.
- *Output frequency = max. frequency*: Motor runs with the maximum frequency until resumption of communication.
- *Stop with trip*: Motor has stopped, a reset is necessary for a restart, see explanation above.
- *Control without PROFIBUS*: Control via PROFIBUS is inactive; control is possible via the terminals and/or the RS 485 standard interface until communication resumes.
- *Selection parameter setup 4*: Parameter setup 4 is selected in parameter 004; the settings of parameter setup 4 are used. Parameter 004 is not reset to the original value upon resumption of communication.
- *Selection parameter setup 2*: Parameter setup 2 is selected in parameter 004; the settings of parameter setup 2 are used. Parameter 004 is not reset to the original value upon resumption of communication.

805 Function Control word bit 10 (BIT 10 FUNCT.)

Value:

Without function (NO FUNCTION)	[0]
★Bit 10 = 1 ⇒ CTW active (BIT 10 = 1 ⇒ CTW ACTIVE)	[1]
Bit 10 = 0 ⇒ CTW active (BIT 10 = 0 ⇒ CTW ACTIVE)	[2]
Bit 10 = 0 ⇒ Timeout (BIT 10 = 0 ⇒ TIMEOUT)	[3]

Function:

According to the PROFIDRIVE profile, the Control word and speed reference value are ignored when bit 10 of the Control word is 0. However, a modification of the function of bit 10 is possible through parameter 805.

This is sometimes necessary since some masters set all bits to 0 in different error situations. In these cases it makes sense to change the function of bit 10 so that the command to stop (coasting) goes to the frequency converter if all bits are 0.

Description of choice:

- *Bit 10 = 1 ⇒ CTW active*: If bit 10 = 0, the Control word and speed reference value are ignored.
- *Bit 10 = 0 ⇒ CTW active*: If bit 10 = 1, the Control word and speed reference value are ignored. If

- all bits of the Control word are 0, the frequency converter will switch to coasting in response here to.
- *Bit 10 = 0 ⇒ Timeout*: If bit 10 = 0, the timeout function selected in parameter 804 is activated.
- *Without function*: Bit 10 is ignored, i.e. the Control word and speed reference value are always valid.



NB!:

During an update of parameter 800 or during the next turn-on procedure, the parameter 805 changes too.

808 Profidrive Status word (PROFIDRV STATUSW)

Value:

★Off 2/3 Non inverted (OFF2/3 NON-INVERTED)	[0]
Off 2/3 Inverted (OFF2/3 INVERTED)	[1]

Function:

This function makes it possible to invert Off 2 and Off 3 bits in the Profidrive Status Word, if Fieldbus profile is selected in p. 512.

Description of choice:

Off 2/3 Non inverted: Off 2/3 bits are inverted contrary to Profidrive profile.

Off 2/3 Inverted: Status word is according to Profidrive profile.

849 Extend Diagnosis

(EXTEND DIAGNOSIS)

Value:

★Disable (DISABLE)	[0]
Alarm (ALARM)	[1]
Alarm and Warning (ALARM AND WARNING)	[2]

Function:

This function allows to expand the diagnosis data to 24 Byte, if this parameter is set to Alarm [1] and Alarms and Warnings [2].

Description of choice:

Please refer to the section *Extended diagnosis* in this manual.

904 PPO type select for DP

(PPO TYPE SELECT)

Value:

★PPO type 1 (PPO TYPE 1)	[900]
PPO type 2 (PPO TYPE 2)	[901]
PPO type 3 (PPO TYPE 3)	[902]

VLT® 5000/ 5000 FLUX/ 6000 HVAC/ 8000 AQUA PROFIBUS

PPO type 4 (PPO TYPE 4)	[903]
PPO type 5 (PPO TYPE 5)	[905]
PPO type 6 (PPO TYPE 6)	[906]
PPO type 7 (PPO TYPE 7)	[907]
PPO type 8 (PPO TYPE 8)	[908]

Function:

Read out of PPO type set by the master.

Description of choice:

- *PPO type 1*: 12 byte PPO with parameter channel for read and write of parameters and 4 bytes of process data (Control/Status word and reference/actual output frequency).
- *PPO type 2*: 20 byte PPO as PPO type 1 with 8 additional bytes of selectable process data.
- *PPO type 3*: 4 byte process data (Control/Status word and reference/actual output frequency).
- *PPO type 4*: 12 byte process data, as process data part of PPO type 2.
- *PPO type 5*: 28 byte as PPO type 2 with 8 additional bytes of selectable process data.
- *PPO type 6*: 8 byte Control/Status word and reference/actual output frequency and additional 4 byte process data.
- *PPO type 7*: 16 byte Control/Status word and reference/actual output frequency and additional 12 byte process data.
- *PPO type 8*: 20byte Control/Status word and reference/actual output frequency and additional 16 byte process data.

A detailed description of the PPO types can be found in the section *PPO description (Overview)*.

915 PCD config. write

(PCD IN WR-)

Selections:

Sub index 1 (PCD3)	Parameter #
Sub index 2	Parameter #
Sub index 3	Parameter #
Sub index 4	Parameter #
Sub index 5	Parameter #
Sub index 6	Parameter #
Sub index 7	Parameter #
Sub index 8	Parameter #

Function:

Different parameters may be assigned to the PCD 3-10 of the PPOs (the max.number of the PCD depends on

the PPO type). The values in PCD 3-10 are written to the selected parameters in form of data values.

Write access to parameter 915 via Profibus or standard RS 485 or LCP2.

Description of choice:

The sequence of the sub-indexes corresponds to the sequence of the PCD in the PPO, i.e. sub-index 1 = PCD 3, sub-index 2 = PCD 4 etc. Each sub-index may contain the number of any frequency converter parameter that can be written to.

Each PCD is defined as a word. If data should be written to a parameter that has an attribute of Integer 32 or Unsigned 32 the parameter number should be defined twice in the following PCD's: PCD 3 and 4, PCD 5 and 6, PCD 7 and 8 or PCD 9 and 10. See example by parameter 916 PCD config. Read.



NB!:

First the odd subindex must be written. Otherwise the data will be interpreted as 2 low words.

916 PCD config. read

(PCD IN RD-)

Selections:

Sub index 1 (PCD3)	Parameter #
Sub index 2	Parameter #
Sub index 3	Parameter #
Sub index 4	Parameter #
Sub index 5	Parameter #
Sub index 6	Parameter #
Sub index 7	Parameter #
Sub index 8	Parameter #

Function:

Different parameters may be assigned to the PCD 3-10 of the PPOs (the max.number of the PCD depends on the PPO type). The values in PCD 3-10 are read from the selected parameters in form of data values.

Write access to parameter 916 via Profibus or standard RS 485 or LCP2.

Description of choice:

The sequence of the sub-indexes corresponds to the sequence of the PCD in the PPO, i.e. sub-index 1 = PCD 3, sub-index 2 = PCD 4 etc. Each sub-index may contain the number of any frequency converter parameter.

VLT® 5000/ 5000 FLUX/ 6000 HVAC/ 8000 AQUA PROFIBUS

Each PCD is defined as a word. If data should be read from a parameter that has an attribute of Integer 32 or Unsigned 32 the parameter should be defined twice in the following PCD's: PCD 3 and 4, PCD 5 and 6, PCD 7 and 8 or PCD 9 and 10.



NB!:

Note: The odd subindex must be written first. Otherwise the data will be interpreted as 2 low words.1

Example PPO type 6:

PCD 1	CTW/STW	
PCD 2	MRV/MAV	
PCD 3	Par. 515	
PCD 4	Par. 518	
PCD 5	Par. 520	High word
PCD 6	Par. 520	Low word
PCD 7	Par. 538	High word
PCD 8	Par. 538	Low word

CTW/STW = Control word / Status word = 16 bit

MRV/MAV = Main Reference Value / Main

Actual Value = 16 bit

Par 515 Data readout: Reference % =

Datatype 3 ⇒ Integer 16

Par 518 data readout: Frequency = Datatype

3 ⇒ Integer 16

Par 520 Data readout= Motor current =Datatype

7 ⇒ Unsigned 32

Par 538 Data readout: Alarm Word = Datatype

7 ⇒ Unsigned 32

917 Spontaneous/event messages

(SPONT. MESSAGE)

Value:

★Off (OFF)	[0]
On (ON)	[1]

Function:

The spontaneous and event messages may be switched if the frequency converter is to report a message in the event of a warning or alarm status. A description of the spontaneous and event messages can be found in section *PCA processing*.

Description of choice:

- OFF: The frequency converter does not report a spontaneous or event message in the warning or alarm status.
- ON: When PPOs are, the frequency converter reports a spontaneous message in the event of a warning or alarm status.

918 Station address

(STATION ADDR)

Value:

0 -125

★126

Function:

All stations connected to the same bus must have a unique address. The station address can be set in parameter 918.



NB!:

A change in parameter 918 is executed at next power up or if parameter 800 is updated. Please see section Station address in this manual for further information.

927 PCV operating authority

(PARAMETER EDIT)

Value:

Disable [0]

★Enable [1]

Function:

The parameter channel PCV can be blocked so that the modification of parameters through this channel is not possible. Access through the standard RS 485 interface is still possible.



NB!:

When parameters 927 and 928 are deactivated, the "Warning 34" in the display of the frequency converter will also be suppressed.

Description of choice:

- Disable: Parameter processing through the PROFIBUS is not active.

- Enable: Parameter processing through the PROFIBUS is active.

928 Control authority

(PROCESS CONTROL)

Value:

Disable [0]

★Enable [1]

Function:

The process control (adjustment of Control word speed reference value and of the following variable PCD) can be blocked. Control through the control card terminals is still possible via the terminals, depending on how the parameters 502-508 have been programmed.



NB!:

When parameters 927 and 928 are deactivated, the "Warning 34" in the display of the frequency converter will also be suppressed.

Description of choice:

If Disable [0] is selected, process control through Profibus is not active, but standard RS 485 is active. If Enable [1] is selected, process control through Profibus is active, but standard RS 485 is not active.



NB!:

Please note, that the motor may start without advance warning when parameter 928 has been changed, and start commands are present.

953 Warning parameter 1

(WARN. PARA)

Value:

Read only

Function:

In this parameter it is possible to read out warning messages via standard bus or Profibus. This parameter is not available via LCP, but the warning message can be seen by choosing Com warning word as display readout. A bit is assigned to every warning (see the following list).

Bit	Bit= "1" when:
0 LSB	Connection with DP-master is not ok
1	Not used
2	FDL (Field-bus Data link Layer) is not ok
3	Clear dat command received
4	Actual value is not updated
5	Spontaneous message FIFO overflow
6	PROFIBUS ASIC is not transmitting
7	Initialising of PROFIBUS option is not ok
8	Not used
9	Not used
10	Not used
11	Not used
12	Fatal DPR-handling error/Error code during init.: Bit 0
13	Fatal DPR-handling error/Error code during init.: Bit 1
14	Fatal DPR-handling error/Error code during init.: Bit 2
15 MSB	Fatal DPR-handling error/Error code during init.: Bit 3

Explanation of error codes:

Depending of Bit 7 the corresponding error codes can be seen from Bit 12-15.

Bit 7 = 1: Initialisation failure

Code

0	OK
1	Init. channel not empty
2	No resp. on command "Init. SPC3 controller"
3	No resp. on command "No action"
4	No resp. on writin ini.-data
5	No valid resp. on writing init.-data
6	No positive resp. on writing init.-data

Bit 7 = 0: Run time failure

Code

0	OK
1	Fatal error in warning channel
2	Fatal error in spontaneous channel
3	Fatal error in channel for input of process data
4	Fatal error in channel for out of process data
5	Fatal error in parameter channel 1
6	Fatal error in parameter channel 2
7	Fatal error in parameter channel 3
15	Fatal error in DPR form SPC3

964 Identification

Selections:

0	Manufacturer
1	Device type
2	Version
3	Firmware date year
4	Firmware date month
5	Number of axes
6	Profibus version
7	Database version
8	Power unit ID
9	BMC software

Function:

This parameter contains the identification of a Profibus slave. This parameter is read only and only accessible via the Profibus V1 communication.

965 Profile Number

(PROFILE NUMBER)

Value:

Profile number 1. octet Manufacturer	[3]
Profile number 2. octet	[3]

VLT® 5000/ 5000 FLUX/ 6000 HVAC/ 8000 AQUA PROFIBUS

Function:

This parameter contains the profile number which a Profibus slave supports. This parameter is read only and only accessible via the Profibus V1 communication.

967 Control word

(CONTROL WORD)

Value:

16 bit binary code
No control panel access

Function:

This parameter is read only and can only be accessed via the Profibus communication.

968 Status word

(STATUS WORD)

Value:

Read only (16 bit binary code)
No control panel access

Function:

This parameter is read only and only accessible via the Profibus communication.

970 Edit setup selection

(EDIT SETUP SELECT)

Value:

Factory Setup	[0]
Setup 1 (SETUP 1)	[1]
Setup 2 (SETUP 2)	[2]
Setup 3 (SETUP 3)	[3]
Setup 4 (SETUP 4)	[4]
★Active setup (ACTIVE SETUP)	[5]

Function:

This parameter is to be used for accessing frequency converter parameters in various setups from a master class 1 (e.g. PLC).
Please see section *Read/Write on VLT frequency converter parameters*.

971 Store data values

(STORE DATA VALUE)

Value:

★No action (OFF)	[0]
Store active setup (STORE ACTIVE SETUP)	[1]
Store edit setup (STORE EDIT SETUP)	[2]
Store all setups (STORE ALL SETUPS)	[3]

Function:

Parameter values modified through PROFIBUS master class 1 are only saved in RAM, i.e. the modifications are lost in the event of a power failure. This parameter is used to activate a function by means of which all parameter values are saved in EEPROM, preserving them even in the case of a power failure.

Description of choice:

- *No action*: The function is not active.
- *Store active setup*: All parameter setups of the active setup are saved in EEPROM. The value returns to Not active after all parameter values have been saved.
- *Store edit setup (par. 970)*: All parameter setups of the setup being processed are saved in EEPROM. The value returns to Not active after all parameter values have been saved.
- *Store all setups*: All parameter setups in all setups are saved in EEPROM. The value returns to Not active after all parameter values have been saved.

980-982 Defined parameters

(DEFINED PARAM.)

Value:

Read only

Function:

The three parameters hold a list of all the parameters that are defined in the VLT 5000/5000 FLUX/6000 HVAC and 8000 AQUA. It is possible to read single elements of the list by DP by using the corresponding subindex. The subindexes start at 1 and follow the order of the parameter numbers.

Each parameter holds up to 116 elements (parameter numbers).

When a 0 is returned as parameter number the list ends.

990-992 Modified parameters

(MODIFI. PARAM.)

Value:

Read only

Function:

The three parameters hold a list of all the VLT 5000/5000 FLUX/6000 HVAC and 8000 AQUA parameters that have been changed from factory setting. It is possible to read single elements of the list by DP by using the corresponding subindex. The subindexes start at 1 and follow the order of the parameter numbers. Each parameter holds up to 116 elements (parameter numbers).

numbers). The number of parameters (990, 991 and 992) in use depends on how many parameters have been changed from factory setting.

Read only parameters, as for example data read out parameters, will not be registered as modified eventhough they are changing.

When a 0 is returned as parameter number the list ends.

■ **Parameter access**

■ **Read/Write on VLT frequency converters**

In an automation system, frequency converter parameters can be accessed either from the Process controller (i.e. PLC), or by various kinds of HMI equipment. In order not to interfere access from controllers and tools, the following should be taken into consideration:

Parameter access in the drive is performed in two logical parameter channels, which can be individually programmed to access a certain parameter setup via parameters 005 *Programming Setup* and 970 *Parameter setup selection*.

This means, that before writing or reading to a parameter in a certain frequency converter set-up from a PLC, the parameter 970 must be set to the desired set-up. For access from HMI equipment, the access is controlled by parameter 005.

The figure below shows this behaviour, and the possible sources of the two logical parameter channels.

VLT frequency converter

Access from process control e.g. PLC:

- PCV channel (DP Vo)
- MSAC Master Class 1

Access from HMI:

- Local Control Panel
- FC standard interface
- MSAC Master class 2

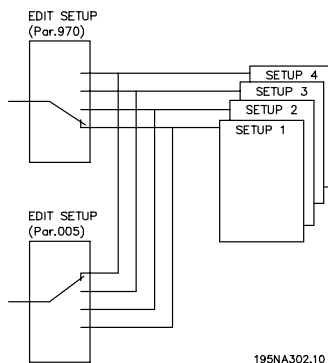

195NA302.10

Please note, that even though these two logical parameter channels are separated, data conflict can occur, if write on parameters is made from a HMI unit into a set-up which is actively used by the frequency converter or used by the process controller (e.g. PLC).



NB!:

For backward compability reasons the following behaviour must be observed:

A Read or Write on parameter 970 via the MSAC master class 2 connection will be accepted, but the value will internally be read /written to parameter 005.

A Read or Write on parameter 005 via the process controller channel will be accepted, but the value will internally be read/written to parameter 970.

For parameter store, the following should be observed:



NB!:

A Write command to a frequency converter parameter via the MSAC Master class 2 connection will be stored in RAM and in Non Volatile Memory. Please note, that continuous writing to frequency converter parameters via the MSAC Master class 2 connection should be avoided in order not to damage the Non Volatile Memory.

A Write command to a frequency converter parameter via the Process Control channel will be stored in RAM only. Store in Non Volatile Memory is possible by writing a store command to parameter 971 Save data values, which will result in store of the entire set-up in NVRAM.

The table below shows how data write from various sources are stored in the frequency converter:

Data source	RAM	NVRAM
PCV channel (DP Vo)	Yes	Store set-up by parameter 971
MSAC Master Class 1	Yes	Store set-up by parameter 971
Local Control Panel	Yes	Yes
MCT 10 software via FC interface	Yes	Yes
MCT 10 software via MSAC 2	Yes	Yes
FC standard interface	Yes	Yes, by specific Write command
MSAC Master Class 2	Yes	Yes

■ **Warnings and alarm messages**

There is a clear distinction between alarm messages and warnings. In the event of a fault (alarm), the frequency converter issues an error condition and responds in the manner predetermined in the Control word. As soon as the cause of the fault has been repaired, the master must confirm the fault message for the frequency converter in order to start again. A warning is issued as soon as a warning condition occurs. This ceases as soon as the normal operating conditions have been re-established without the operation being disrupted.

Warning

Every warning within the frequency converter is represented by a single bit in a warning word. A warning word is always an active parameter. The bit status FALSE [0] means no warning, the bit status TRUE [1] means warning.

Every change of a bit in the warning word generates a spontaneous message.

Apart from the notification by the warning word, the master is also being informed by a change in bit 7 of the Status word.

Fault messages

After a fault message (alarm), the frequency converter issues an error condition (bit 3 in the Status word). The frequency converter can resume operations only after the fault has been repaired and the master has confirmed the fault message by a change of bit 7 in the Control word (positive slope from "0" to "1").

Every fault within the frequency converter is represented by a single bit in an alarm word. The alarm word is always an active parameter. The bit status FALSE [0] means no alarm, the bit status TRUE [1] means alarm.

Every change of a bit in the alarm word generates a spontaneous message.

■ **Spontaneous messages**

If a fault or warning condition occurs, the frequency converter issues a spontaneous message provided that the spontaneous message in parameter 917 has been activated. Instead of responding to the request from the master, the frequency converter replaces the requested response by the fault or warning message.



NB!:

Explanations regarding the individual bits of the warning words and of the alarm word can be found in the Operation Instructions of the VLT 5000 (MG.51.AX.YY), VLT 5000 FLUX (MG.55.AX.YY), 6000 HVAC (MG.60.AX.YY) and 8000 AQUA (MG.80.AX.YY).

■ **Additional display readings**

If a frequency converter is equipped with a PROFIBUS interface, it can display the following readings in addition to the messages described in the VLT 5000/5000 Flux/6000 HVAC/8000 AQUA product manual:

Warnings:

WARN. 34

PROFIBUS COMM. FAULT

- There is no connection to the master. The reason could be that the master has stopped (or is in an error status), or that the PROFIBUS connection to the frequency converter is interrupted.

- There is an SPM overflow in the FIFO buffer for spontaneous messages. (see "Example of a spontaneous message").



NB!:

When parameters 927 and 928 are deactivated, the "Warning 34" in the display of the frequency converter will also be suppressed.

Alarm conditions

ALARM

PROFIBUS OPT. FAULT

- The option card has been destroyed by electrical interference, or the option card is defective and needs to be replaced.

Warning and alarm messages

VLT® 5000/ 5000 FLUX/ 6000 HVAC/ 8000 AQUA PROFIBUS

■ Warning word, extended Status word and Alarm word

Warning word, extended word and Alarm word are shown on the display in Hex format. If there is more than one warning or alarm, a sum of all warnings or alarms will be shown. Warning word, extended word and Alarm word can also be displayed using the serial bus in parameter 540, 541 and 538.

VLT 6000		
Bit (Hex)	Unit diagnose bit	Extended word (P. 532)
00000001	80	Overvoltage control active
00000002	81	Start delay
00000004	82	Sleep boost active
00000008	83	Sleep mode active
00000010	84	Automatic mode adaptation completed
00000020	85	Automatic mode adaptation running
00000040	86	Reversing and start
00000080	87	Ramp operation
00000100	72	Reversing
00000200	73	Speed = reference
00000400	74	Running
00000800	75	Local ref. = 0 Remote controlled ref. = 1
00001000	76	OFF mode = 1
00002000	77	Auto mode = 0 Hand mode = 1
00004000	78	Start blocked
00008000	79	Start blocked signal missing
00010000	64	Freeze output
00020000	65	Freeze output blocked
00040000	66	Jogging
00080000	67	Jog blocked
00100000	68	Stand by
00200000	69	Stop
00400000	70	DC stop
00800000	71	Drive ready
01000000	56	Relay 123 active
02000000	57	Drive ready
04000000	58	Control ready
08000000	59	Start prevented
10000000	60	Profibus OFF3 active
20000000	61	Profibus OFF2 active
40000000	62	Profibus OFF1 active
80000000	63	Reserved

VLT 5000		
Bit (Hex)	Unit diagnose bit	Alarm word, binary (P. 538)
00000001	112	Brake test failed
00000002	113	Trip lock
00000004	114	AMA tuning not OK
00000008	115	AMA tuning OK
00000010	116	Power up fault
00000020	117	ASIC fault
00000040	118	HPFB bus timeout
00000080	119	Standard bus timeout
00000100	104	Short-circuiting
00000200	105	Switchmode fault
00000400	106	Earth fault
00000800	107	Overcurrent
00001000	108	Torque limit
00002000	109	Motor thermistor
00004000	110	Motor overload
00008000	111	Inverter overload
00010000	96	Undervoltage
00020000	97	Overvoltage
00040000	98	Phase fault
00080000	99	Live zero fault (4-20 mA current signal low)
00100000	100	Heat sink temperature too high
00200000	101	Motor phase W missing
00400000	102	Motor phase V missing
00800000	103	Motor phase U missing
01000000	88	Quick discharge not OK
02000000	89	Fieldbus communication fault
04000000	90	Mains failure
08000000	91	Inverter fault
10000000	92	Brake power fault
20000000	93	Encoder loss
40000000	94	Safety interlock
80000000	95	Reserved

**VLT® 5000/ 5000 FLUX/ 6000 HVAC/
8000 AQUA PROFIBUS**

VLT 5000		
Bit (Hex)	Unit diagnose bit	Warning word 1 (P. 540)
00000001	48	Fault during brake test
00000002	49	Fault in EEprom on control card
00000004	50	Fault in EEprom on power card
00000008	51	HPFB bus timeout
00000010	52	Serial communication timeout
00000020	53	Overcurrent
00000040	54	Torque limit
00000080	55	Motor thermistor
00000100	40	Motor overload
00000200	41	Inverter overload
00000400	42	Undervoltage
00000800	43	Overvoltage
00001000	44	Voltage warning low
00002000	45	Voltage warning high
00004000	46	Phase fault
00008000	47	No motor
00010000	32	Live zero fault
00020000	33	Under 10 Volt (terminal 50)
00040000	34	Not used
00080000	35	Brake resistor power 100%
00100000	36	Brake resistor fault
00200000	37	Brake transistor fault
00400000	38	Out of frequency range
00800000	39	Fieldbus communication fault
01000000	24	Not used
02000000	25	Mains failure
04000000	26	Motor too small
08000000	27	Motor too big
10000000	28	Check p. 103 and p. 105
20000000	29	Check p. 104 and p. 106
40000000	30	Encoder loss
80000000	31	Not used

VLT 5000		
Bit (Hex)	Unit diagnose bit	Extended word (P. 541)
00000001	80	Ramping
00000002	81	Automatic motor tuning
00000004	82	Start clockwise/anti-clockwise
00000008	83	Slow down
00000010	84	Catch-up
00000020	85	Feedback high
00000040	86	Feedback low
00000080	87	Output current high
00000100	72	Output current low
00000200	73	Output frequency high
00000400	74	Output frequency low
00000800	75	Brake test ok
00001000	76	Braking max.
00002000	77	Braking
00004000	78	Quick discharge OK
00008000	79	Out of frequency range
00010000	64	Not used
00020000	65	Not used
00040000	66	Not used
00080000	67	Not used
00100000	68	Not used
00200000	69	Not used
00400000	70	Not used
00800000	71	Not used
01000000	56	Not used
02000000	57	Not used
04000000	58	Not used
08000000	59	Not used
10000000	60	PB acyclic MC1 communication
20000000	61	PB acyclic MC2 communication
40000000	62	Not used
80000000	63	Not used

Warning and alarm messages

VLT 5000		
Bit (Hex)	Unit diagnose bit	Alarm word (P. 953)
00000001	128	Connection with DP-master is not OK
00000002	129	Not used
00000004	130	FDL is not OK
00000008	131	Clear data command received
00000010	132	Actual value is not updated
00000020	133	Spontaneous message FIFO overflow
00000040	134	PROFIBUS ASIC is not transmitting
00000080	135	Initialising of PROFIBUS is not OK
00000100	120	Not used
00000200	121	Not used
00000400	122	Not used
00000800	123	Not used
00001000	124	Fatal DPR error during init: Bit 0
00002000	125	Fatal DPR error during init: Bit 1
00004000	126	Fatal DPR error during init: Bit 2
00008000	127	Fatal DPR error during init: Bit 3

■ Station address

The station address of slave can be selected via

- Hardware switch
- Parameter 918 via bus or LCP 2
- Command "Set Station Address" of Profibus DP

The address via the hardware switch is valid, if the switch is set between 0-125. All selections via parameter 918 or "Set Station Address" command will be rejected. The address setting will only be effective at power up. Changing during run time will be effective at next power up.

The setting of address via parameter 918 is possible, if the hardware switch is set to 126 or 127 (factory setting). A new address is effective at a new power up.

The setting of the address via the "Set Station Address" command is possible, if the hardware switch is set to 126 or 127 (factory setting). By the "Set Station Address" command it is possible to lock the programmed address, which makes it impossible to change the address by this command. The address setting will be unlocked, if the parameter 918 or the address switch is changed followed by a power cycle. A new address is effective immediate after *Set Station Address* -command.

■ **Extended Diagnosis**

By the extended diagnose function it is possible to receive alarm and warning information from the frequency converter. The setting of parameter 849 determines which frequency converter events should trigger the extended diagnose function.

If parameter 849 is set to Disable [0], no extended diagnose data is sent regardless whether they appear in the frequency converter.

If parameter 849 is set to Alarms [1], extended diagnose data is sent, if one or more alarms arrive in the Alarm parameters. If parameter 849 is set to Alarms/Warnings [2], extended diagnose data is sent if one or more alarms/warnings arrive in the Alarm parameters or the warning parameter.

The sequence of an extended diagnose is as follows:

If an Alarm or warning appears, the frequency converter will indicate that to the master by sending a high prior message via the output data telegram.

This will cause the master to ask the frequency converter for extended diagnose information, which will be replied by the frequency converter.

When the Alarm/warning disappears, the frequency converter will again indicate that to the master, and on the following request from the master, return a standard DP diagnose frame (6 bytes).

The extended diagnose frame has the following content:

Byte	Content	Description
0 through 5	Standard DP Diagnose data	Standard DP Diagnose frame
6	Pdu length xx	Header of Extended diagnostic data
7	Status type = 0x81	Header of Extended diagnostic data
8	Slot = 0	Header of Extended diagnostic data
9	Status info = 0	Header of Extended diagnostic data
10 through 13	VLT parameter 540	VLT warning word
14 through 17	VLT parameter 541	VLT Status word
18 through 21	VLT parameter 538	VLT Alarm word
22 through 23	VLT parameter 953	Communication warning word

Parameter list VLT 5000

PNU #	Parameter description	Factory setting	Range	Changes during operation	4-Setup	Conversion index	Data type
001	Language	English		Yes	No	0	5
002	Local/remote control	Remote control		Yes	Yes	0	5
003	Local reference	000.000		Yes	Yes	-3	4
004	Active setup	Setup 1		Yes	No	0	5
005	Programming setup	Active setup		Yes	No	0	5
006	Copying of setups	No copying		No	No	0	5
007	LCP copy	No copying		No	No	0	5
008	Display scaling of motor frequency	1	0.01 - 500.00	Yes	Yes	-2	6
009	Display line 2	Frequency [Hz]		Yes	Yes	0	5
010	Display line 1.1	Reference [%]		Yes	Yes	0	5
011	Display line 1.2	Motor current [A]		Yes	Yes	0	5
012	Display line 1.3	Power [kW]		Yes	Yes	0	5
013	Local control/configura	LCP digital control/as par.100		Yes	Yes	0	5
014	Local stop	Possible		Yes	Yes	0	5
015	Local jog	Not possible		Yes	Yes	0	5
016	Local reversing	Not possible		Yes	Yes	0	5
017	Local reset of trip	Possible		Yes	Yes	0	5
018	Lock for data change	Not locked		Yes	Yes	0	5
019	Operating state at power-up, local control	Forced stop, use saved ref.		Yes	Yes	0	5
027	Warning readout	Warning in line 1/2		Yes	No	0	5

Changes during operation:

"Yes" means that the parameter can be changed, while the frequency converter is in operation. "No" means that the frequency converter must be stopped before a change can be made.

4-Setup:

"Yes" means that the parameter can be programmed individually in each of the four setups, i.e. the same parameter can have four different data values. "No" means that the data value will be the same in all four setups.

Conversion index:

This number refers to a conversion figure to be used when writing or reading by means of a frequency converter.

Conversion index	Conversion factor
74	0.1
2	100
1	10
0	1
-1	0.1
-2	0.01
-3	0.001
-4	0.0001

Data type:

Data type shows the type and length of the telegram.

Data type	Description
3	Integer 16
4	Integer 32
5	Unsigned 8
6	Unsigned 16
7	Unsigned 32
9	Text string

VLT® 5000/ 5000 FLUX/ 6000 HVAC/ 8000 AQUA PROFIBUS

PNU #	Parameter description	Factory setting	Range	Changes during operation	4-Setup	Conversion index	Data type
100	Configuration	Speed control, open loop		No	Yes	0	5
101	Torque characteristics	High - constant torque		Yes	Yes	0	5
102	Motor power	Depends on the unit	0.18-600 kW	No	Yes	1	6
103	Motor voltage	Depends on the unit	200 - 600 V	No	Yes	0	6
104	Motor frequency	50 Hz / 60 Hz		No	Yes	0	6
105	Motor current	Depends on the unit	0.01 - I _{VLT,MAX}	No	Yes	-2	7
106	Rated motor speed	Depends on the unit	100-60000 rpm	No	Yes	0	6
107	Automatic motor adaptation, AMA	Adaptation off		No	No	0	5
108	Stator resistor	Depends on the unit		No	Yes	-4	7
109	Stator reactance	Depends on the unit		No	Yes	-2	7
110	Motor magnetizing, 0 rpm	100 %	0 - 300 %	Yes	Yes	0	6
111	Min. frequency normal magnetizing	1.0 Hz	0.1 - 10.0 Hz	Yes	Yes	-1	6
112							
113	Load compensation at low speed	100 %	0 - 300 %	Yes	Yes	0	6
114	Load compensation at high speed	100 %	0 - 300 %	Yes	Yes	0	6
115	Slip compensation	100 %	-500 - 500 %	Yes	Yes	0	3
116	Slip compensation time constant	0.50 s	0.05 - 1.00 s	Yes	Yes	-2	6
117	Resonance dampening	100 %	0 - 500 %	Yes	Yes	0	6
118	Resonance dampening time constant	5 ms	5 - 50 ms	Yes	Yes	-3	6
119	High starting torque	0.0 sec.	0.0 - 0.5 s	Yes	Yes	-1	5
120	Start delay	0.0 sec.	0.0 - 10.0 s	Yes	Yes	-1	5
121	Start function	Coasting in start delay time		Yes	Yes	0	5
122	Function at stop	Coasting		Yes	Yes	0	5
123	Min. frequency for activating function at stop	0.0 Hz	0.0 - 10.0 Hz	Yes	Yes	-1	5
124	DC holding current	50 %	0 - 100 %	Yes	Yes	0	6
125	DC braking current	50 %	0 - 100 %	Yes	Yes	0	6
126	DC braking time	10.0 sec.	0.0 - 60.0 sec.	Yes	Yes	-1	6
127	DC brake cut-in frequency	Off	0.0-par. 202	Yes	Yes	-1	6
128	Motor thermal protection	No protection		Yes	Yes	0	5
129	External motor fan	No		Yes	Yes	0	5
130	Start frequency	0.0 Hz	0.0-10.0 Hz	Yes	Yes	-1	5
131	Initial voltage	0.0 V	0.0-par. 103	Yes	Yes	-1	6
145	Minimum DC brake time	0 sec.	0 - 10 sec.	Yes	Yes	-1	6

VLT® 5000/ 5000 FLUX/ 6000 HVAC/ 8000 AQUA PROFIBUS

PNU #	Parameter description	Factory setting	Range	Changes during operation	4-Setup	Conversion index	Data type
200	Output frequency range/direction	Only clockwise, 0-132 Hz		No	Yes	0	5
201	Output frequency low limit	0.0 Hz	0.0 - f_{MAX}	Yes	Yes	-1	6
202	Output frequency high limit	66 / 132 Hz	f_{MIN} - par. 200	Yes	Yes	-1	6
203	Reference/feedback area	Min - max		Yes	Yes	0	5
204	Minimum reference	0.000	-100,000.000-Ref _{MAX}	Yes	Yes	-3	4
205	Maximum reference	50.000	Ref _{MIN} -100,000.000	Yes	Yes	-3	4
206	Ramp type	Linear		Yes	Yes	0	5
207	Ramp-up time 1	Depends on unit	0.05 - 3600	Yes	Yes	-2	7
208	Ramp-down time 1	Depends on unit	0.05 - 3600	Yes	Yes	-2	7
209	Ramp-up time 2	Depends on unit	0.05 - 3600	Yes	Yes	-2	7
210	Ramp-down time 2	Depends on unit	0.05 - 3600	Yes	Yes	-2	7
211	Jog ramp time	Depends on unit	0.05 - 3600	Yes	Yes	-2	7
212	Quick stop ramp-down time	Depends on unit	0.05 - 3600	Yes	Yes	-2	7
213	Jog frequency	10.0 Hz	0.0 - par. 202	Yes	Yes	-1	6
214	Reference function	Sum		Yes	Yes	0	5
215	Preset reference 1	0.00 %	- 100.00 - 100.00 %	Yes	Yes	-2	3
216	Preset reference 2	0.00 %	- 100.00 - 100.00 %	Yes	Yes	-2	3
217	Preset reference 3	0.00 %	- 100.00 - 100.00 %	Yes	Yes	-2	3
218	Preset reference 4	0.00 %	- 100.00 - 100.00 %	Yes	Yes	-2	3
219	Catch up/slow down value	0.00 %	0.00 - 100 %	Yes	Yes	-2	6
220							
221	Torque limit for motor mode	160 %	0.0 % - xxx %	Yes	Yes	-1	6
222	Torque limit for regenerative operation	160 %	0.0 % - xxx %	Yes	Yes	-1	6
223	Warning: Low current	0.0 A	0.0 - par. 224	Yes	Yes	-1	6
224	Warning: High current	$I_{VLT,MAX}$	Par. 223 - $I_{VLT,MAX}$	Yes	Yes	-1	6
225	Warning: Low frequency	0.0 Hz	0.0 - par. 226	Yes	Yes	-1	6
226	Warning: High frequency	132.0 Hz	Par. 225 - par. 202	Yes	Yes	-1	6
227	Warning: Low feedback	-4000.000	-100,000.000 - par. 228	Yes		-3	4
228	Warning: High feedback	4000.000	Par. 227 - 100,000.000	Yes		-3	4
229	Frequency bypass, bandwidth	OFF	0 - 100 %	Yes	Yes	0	6
230	Frequency bypass 1	0.0 Hz	0.0 - par. 200	Yes	Yes	-1	6
231	Frequency bypass 2	0.0 Hz	0.0 - par. 200	Yes	Yes	-1	6
232	Frequency bypass 3	0.0 Hz	0.0 - par. 200	Yes	Yes	-1	6
233	Frequency bypass 4	0.0 Hz	0.0 - par. 200	Yes	Yes	-1	6
234	Motor phase monitor	Enable		Yes	Yes	0	5

VLT® 5000/ 5000 FLUX/ 6000 HVAC/ 8000 AQUA PROFIBUS

PNU #	Parameter description	Factory setting	Range	Changes during operation	4-Setup	Conversion index	Data type
300	Terminal 16, input	Reset		Yes	Yes	0	5
301	Terminal 17, input	Freeze reference		Yes	Yes	0	5
302	Terminal 18 Start, input	Start		Yes	Yes	0	5
303	Terminal 19, input	Reversing		Yes	Yes	0	5
304	Terminal 27, input	Coasting stop, inverse		Yes	Yes	0	5
305	Terminal 29, input	Jog		Yes	Yes	0	5
306	Terminal 32, input	Choice of setup, msb/speed up		Yes	Yes	0	5
307	Terminal 33, input	Choice of setup, lsb/speed down		Yes	Yes	0	5
308	Terminal 53, analogue input voltage	Reference		Yes	Yes	0	5
309	Terminal 53, min. scaling	0.0 V	0.0 - 10.0 V	Yes	Yes	-1	5
310	Terminal 53, max. scaling	10.0 V	0.0 - 10.0 V	Yes	Yes	-1	5
311	Terminal 54, analogue input voltage	No operation		Yes	Yes	0	5
312	Terminal 54, min. scaling	0.0 V	0.0 - 10.0 V	Yes	Yes	-1	5
313	Terminal 54, max. scaling	10.0 V	0.0 - 10.0 V	Yes	Yes	-1	5
314	Terminal 60, analogue input current	Reference		Yes	Yes	0	5
315	Terminal 60, min. scaling	0.0 mA	0.0 - 20.0 mA	Yes	Yes	-4	5
316	Terminal 60, max. scaling	20.0 mA	0.0 - 20.0 mA	Yes	Yes	-4	5
317	Time out	10 sec.	1 - 99 sec.	Yes	Yes	0	5
318	Function after time out	Off		Yes	Yes	0	5
319		0 - I _{MAX} P 0-20 mA		Yes	Yes	0	5
320	Terminal 42, output, pulse scaling	5000 Hz	1 - 32000 Hz	Yes	Yes	0	6
321	Terminal 45, output	0 - f _{MAX} P 0-20 mA		Yes	Yes	0	5
322	Terminal 45, output, pulse scaling	5000 Hz	1 - 32000 Hz	Yes	Yes	0	6
323	Relay 01, output	Ready - no thermal warning		Yes	Yes	0	5
324	Relay 01, ON delay	0.00 sec.	0.00 - 600 sec.	Yes	Yes	-2	6
325	Relay 01, OFF delay	0.00 sec.	0.00 - 600 sec.	Yes	Yes	-2	6
326	Relay 04, output	Ready - remote control		Yes	Yes	0	5
327	Pulse reference, max. frequency	5000 Hz		Yes	Yes	0	6
328	Pulse feedback, max. frequency	25000 Hz		Yes	Yes	0	6
329	Encoder feedback pulse/rev.	1024 pulses/rev.	1 - 4096 pulses/rev.	Yes	Yes	0	6
330	Freeze reference/output function	No operation		Yes	No	0	5
345	Encoder loss timeout	1 sec.	0 - 60 sec	Yes	Yes	-1	6
346	Encoder loss function	OFF		Yes	Yes	0	5
357	Terminal 42, Output minimum scaling	0 %	000 - 100%	Yes	Yes	0	6
358	Terminal 42, Output maximum scaling	100%	000 - 500%	Yes	Yes	0	6
359	Terminal 45, Output minimum scaling	0 %	000 - 100%	Yes	Yes	0	6
360	Terminal 45, Output maximum scaling	100%	000 - 500%	Yes	Yes	0	6
361	Encoder loss threshold	300%	000 - 600 %	Yes	Yes	0	6

VLT® 5000/ 5000 FLUX/ 6000 HVAC/ 8000 AQUA PROFIBUS

PNU #	Parameter description	Factory setting	Range	Changes during operation	4-Setup	Conversion index	Data type
400	Brake function/overvoltage control	Off		Yes	No	0	5
401	Brake resistor, ohm	Depends on the unit		Yes	No	-1	6
402	Brake power limit, kW	Depends on the unit		Yes	No	2	6
403	Power monitoring	On		Yes	No	0	5
404	Brake check	Off		Yes	No	0	5
405	Reset function	Manual reset		Yes	Yes	0	5
406	Automatic restart time	5 sec.	0 - 10 sec.	Yes	Yes	0	5
407	Mains Failure	No function		Yes	Yes	0	5
408	Quick discharge	Not possible		Yes	Yes	0	5
409	Trip delay torque	Off	0 - 60 sec.	Yes	Yes	0	5
410	Trip delay-inverter	Depends on type of unit	0 - 35 sec.	Yes	Yes	0	5
411	Switching frequency	Depends on type of unit	3 - 14 kHz	Yes	Yes	2	6
412	Output frequency dependent switching frequency	Not possible		Yes	Yes	0	5
413	Overmodulation function	On		Yes	Yes	-1	5
414	Minimum feedback	0.000	-100,000.000 - FB _{HIGH}	Yes	Yes	-3	4
415	Maximum feedback	1500.000	FB _{LOW} - 100,000.000	Yes	Yes	-3	4
416	Process unit	%		Yes	Yes	0	5
417	Speed PID proportional gain	0.015	0.000 - 0.150	Yes	Yes	-3	6
418	Speed PID integration time	8 ms	2.00 - 999.99 ms	Yes	Yes	-4	7
419	Speed PID differentiation time	30 ms	0.00 - 200.00 ms	Yes	Yes	-4	6
420	Speed PID diff. gain ratio	5.0	5.0 - 50.0	Yes	Yes	-1	6
421	Speed PID low-pass filter	10 ms	5 - 200 ms	Yes	Yes	-4	6
422	U 0 voltage at 0 Hz	20.0 V	0.0 - parameter 103	Yes	Yes	-1	6
423	U 1 voltage	parameter 103	0.0 - U _{VLT, MAX}	Yes	Yes	-1	6
424	F 1 frequency	parameter 104	0.0 - parameter 426	Yes	Yes	-1	6
425	U 2 voltage	parameter 103	0.0 - U _{VLT, MAX}	Yes	Yes	-1	6
426	F 2 frequency	parameter 104	par.424- par.428	Yes	Yes	-1	6
427	U 3 voltage	parameter 103	0.0 - U _{VLT, MAX}	Yes	Yes	-1	6
428	F 3 frequency	parameter 104	par.426 -par.430	Yes	Yes	-1	6
429	U 4 voltage	parameter 103	0.0 - U _{VLT, MAX}	Yes	Yes	-1	6

VLT® 5000/ 5000 FLUX/ 6000 HVAC/ 8000 AQUA PROFIBUS

PNU #	Parameter description	Factory setting	Range	Changes during operation	4-Setup	Conversion index	Data type
430	F 4 frequency	parameter 104	par.426-par.432	Yes	Yes	-1	6
431	U 5 voltage	parameter 103	.0 - $U_{VLT, MAX}$	Yes	Yes	-1	6
432	F 5 frequency	parameter 104	par.426 - 1000 Hz	Yes	Yes	-1	6
433	Torque proportional gain	100%	0 (Off) - 500%	Yes	Yes	0	6
434	Torque integral time	0.02 sec.	0.002 - 2.000 sec.	Yes	Yes	-3	7
437	Process PID Normal/Inverse control	Normal		Yes	Yes	0	5
438	Process PID anti windup	On		Yes	Yes	0	5
439	Process PID start frequency	parameter 201	$f_{min} - f_{max}$	Yes	Yes	-1	6
440	Process PID proportional gain	0.01	0.00 - 10.00	Yes	Yes	-2	6
441	Process PID integral time	9999.99 sec. (OFF)	0.01 - 9999.99 sec.	Yes	Yes	-2	7
442	Process PID differentiation time	0.00 sec. (OFF)	0.00 - 10.00 sec.	Yes	Yes	-2	6
443	Process PID diff. gain limit	5.0	5.0 - 50.0	Yes	Yes	-1	6
444	Process PID lowpass filter time	0.01	0.01 - 10.00	Yes	Yes	-2	6
445	Flying start	Disable		Yes	Yes	0	5
446	Switching pattern	SFAVM		Yes	Yes	0	5
447	Torque compensation	100%	-100 - +100%	Yes	Yes	0	3
448	Gear ratio	1	0.001 - 100.000	No	Yes	-2	4
449	Friction loss	0%	0 - 50%	No	Yes	-2	6
450	Mains voltage at mains fault	Depends on unit	Depends on unit	Yes	Yes	0	6
453	Speed closed loop gear ratio	1	0.01-100	No	Yes	0	4
454	Dead time compensation	On		No	No	0	5
455	Frequency range monitor	Enable				0	5
457	Phase loss function	Trip		Yes	Yes	0	5
483	Dynamic DC Link compensation	On		No	No	0	5

VLT® 5000/ 5000 FLUX/ 6000 HVAC/ 8000 AQUA PROFIBUS

PNU #	Parameter description	Factory setting	Range	Changes during operation	4-Setup	Conversion index	Data type
500	Address	1	0 - 126	Yes	No	0	6
501	Baudrate	9600 Baud		Yes	No	0	5
502	Coasting	Logic or		Yes	Yes	0	5
503	Quick-stop	Logic or		Yes	Yes	0	5
504	DC-brake	Logic or		Yes	Yes	0	5
505	Start	Logic or		Yes	Yes	0	5
506	Reversing	Logic or		Yes	Yes	0	5
507	Selection of setup	Logic or		Yes	Yes	0	5
508	Selection of speed	Logic or		Yes	Yes	0	5
509	Bus jog 1	10.0 Hz	0.0 - parameter 202	Yes	Yes	-1	6
510	Bus jog 2	10.0 Hz	0.0 - parameter 202	Yes	Yes	-1	6
511							
512	Telegram profile	FC Drive		No	Yes	0	5
513	Bus time interval	1 sec.	1 - 99 s	Yes	Yes	0	5
514	Bus time interval function	Off		Yes	Yes	0	5
515	Data read-out: Reference %			No	No	-1	3
516	Data read-out: Reference unit			No	No	-3	4
517	Data read-out: Feedback			No	No	-3	4
518	Data read-out: Frequency			No	No	-1	6
519	Data read-out: Frequency x Scaling			No	No	-2	7
520	Data read-out: Current			No	No	-2	7
521	Data read-out: Torque			No	No	-1	3
522	Data read-out: Power, kW			No	No	-1	7
523	Data read-out: Power, HP			No	No	-2	7
524	Data read-out: Motor voltage			No	No	-1	6
525	Data read-out: DC link voltage			No	No	0	6
526	Data read-out: Motor temp.			No	No	0	5
527	Data read-out: VLT temp.			No	No	0	5
528	Data read-out: Digital input			No	No	0	5
529	Data read-out: Terminal 53, analogue input			No	No	-2	3
530	Data read-out: Terminal 54, analogue input			No	No	-2	3
531	Data read-out: Terminal 60, analogue input			No	No	-5	3
532	Data read-out: Pulse reference			No	No	-1	7
533	Data read-out: External reference %			No	No	-1	3
534	Data read-out: Status word, binary			No	No	0	6
535	Data read-out: Brake power/2 min.			No	No	2	6
536	Data read-out: Brake power/sec.			No	No	2	6
537	Data read-out: Heat sink temperature			No	No	0	5
538	Data read-out: Alarm word, binary			No	No	0	7
539	Data read-out: VLT Control word, binary			No	No	0	6
540	Data read-out: Warning word, 1			No	No	0	7
541	Data read-out: Extended Status word			No	No	0	7
553	Display text 1			No	No	0	9
554	Display text 2			No	No	0	9
557	Data read-out: Motor RPM			No	No	0	4
558	Data read-out: Motor RPM x scaling			No	No	-2	4
580	Defined parameter			No	No	0	6
581	Defined parameter			No	No	0	6
582	Defined parameter			No	No	0	6

VLT® 5000/ 5000 FLUX/ 6000 HVAC/ 8000 AQUA PROFIBUS

PNU #	Parameter description	Factory setting	Range	Changes during operation	4-Setup	Conversion index	Data type
600	Operating data: Operating hours			No	No	74	7
601	Operating data: Hours run			No	No	74	7
602	Operating data: kWh counter			No	No	1	7
603	Operating data: Number of power-up's			No	No	0	6
604	Operating data: Number of overtemperatures			No	No	0	6
605	Operating data: Number of overvoltages			No	No	0	6
606	Data log: Digital input			No	No	0	5
607	Data log: Bus commands			No	No	0	6
608	Data log: Bus Status word			No	No	0	6
609	Data log: Reference			No	No	-1	3
610	Data log: Feedback			No	No	-3	4
611	Data log: Motor frequency			No	No	-1	3
612	Data log: Motor voltage			No	No	-1	6
613	Data log: Motor current			No	No	-2	3
614	Data log: DC link voltage			No	No	0	6
615	Fault log: Error code			No	No	0	5
616	Fault log: Time			No	No	-1	7
617	Fault log: Value			No	No	0	3
618	Reset of kWh counter	No reset		Yes	No	0	5
619	Reset of hours-run counter	No reset		Yes	No	0	5
620	Operating mode Normal function	Normal function		No	No	0	5
621	Nameplate: VLT type			No	No	0	9
622	Nameplate: Power section			No	No	0	9
623	Nameplate: VLT ordering number			No	No	0	9
624	Nameplate: Software version no.			No	No	0	9
625	Nameplate: LCP identification no.			No	No	0	9
626	Nameplate: Database identification no.			No	No	-2	9
627	Nameplate: Power section identification no.			No	No	0	9
628	Nameplate: Application option type			No	No	0	9
629	Nameplate: Application option ordering no.			No	No	0	9
630	Nameplate: Communication option type			No	No	0	9
631	Nameplate: Communication option ordering no.			No	No	0	9

VLT® 5000/ 5000 FLUX/ 6000 HVAC/ 8000 AQUA PROFIBUS

PNU #	Parameter description	Factory setting	Range	Changes during operation	4-Setup	Conversion index	Data type
800	Protocol selection	1 (= DP)	0-1	yes	no	0	5
801	Baud rate selection	500 kBaud (6)	1-9	yes	no	0	5
802	Minimum station delay	35 (1)	0-1	yes	no	0	5
803	Time after bus error	1	1-99	yes	yes	0	5
804	Response after bus error	Off (0)	0-7	yes	yes	0	5
805	Function Control word bit 10	Bit 10 = 1 ⇒ CTW active (1)	0-3	yes	yes	0	5
806	SAP selection	SAP 63 (0)	0-9	yes	yes	0	5
900	Write PPO type 1		12 bytes	yes	yes	0	5
901	Write PPO type 2		20 bytes	no	no	0	5
902	Write PPO type 3		4 bytes	no	no	0	5
903	Write PPO type 4		12 bytes	no	no	0	5
904	PPO selection for DP	900 (PPO1)	900-903	yes	yes	0	6
907	Read PPO type 1	0	12 bytes	no	no	0	5
908	Read PPO type 2	0	20 bytes	no	no	0	5
909	Read PPO type 3		4 bytes	no	no	0	5
910	Read PPO type 4		12 bytes	no	no	0	5
911	PPO type for FMS read		907-910	yes	yes	0	6
913	Broadcast index		0-32767	yes	yes	0	6
914	Broadcast offset		0-244	yes	yes	0	6
915	PCD write configuration			yes	yes	0	6
916	PCD read configuration			yes	yes	0	6
917 ⁴	Spontaneous/event messages	OFF (0)	ON/OFF	yes	yes	0	6
918	User address	0	1-126	yes	no	0	6
927	PCV operating authority	With PROFIBUS (1)	0-1	yes	yes	0	6
928	Control authority	With PROFIBUS (1)	0-1	yes	yes	0	6
953	Warning messages			no	no	0	6
967	Control word		16 Bit	yes	no	0	6
968	Status word		16 Bit	no	no	0	6
969	Time difference			no	no	0	6
970	Parameter setup selection	Active setup = P001	0-6	yes	yes	0	5
971 ⁵	Save data values	OFF (0)	ON/OFF	yes	no	0	5
980				no	no	0	6
981	Defined parameters						
982							
990				no	no	0	6
991	Modified parameters						
992							

* Automatic reset to (0).

4) Available in all 4 setups.

5) Only in stop mode

■ Reference for other parameter lists

For parameter lists for VLT 5000 FLUX, VLT 6000 HVAC and VLT 8000 AQUA please consult the respective Operating Instructions.

Product series	Literature number
VLT 5000 FLUX	MG.51.AX.YY
VLT 6000 HVAC	MG.60.AX.YY
VLT 8000 AQUA	MG.80.AX.YY

■ **Glossar**

Changes during operation

"Yes" means that the parameter can be changed, while the frequency converter is in operation. "No" means that the frequency converter must be stopped before a change can be made.

4-Setup

"Yes" means that the parameter can be programmed individually in each of the four setups, i.e. the same parameter can have four different data values.

"No" means that the data value will be the same in all four setups.

Conversion index

This number refers to a conversion figure to be used when writing or reading by means of a frequency converter.

Conversion index	Conversion factor
74	0.1
2	100
1	10
0	1
-1	0.1
-2	0.01
-3	0.001
-4	0.0001

Data type

The data type shows the type and length of the telegram.

Data type	Description
3	Integer 16
4	Integer 32
5	Unsigned 8
9	Unsigned 16
7	Unsigned 32
9	Text string

■ **Abbreviations used**

English	German	Description
ALI	-	Application Layer Interface
ATTR	-	Connection Attribute
CTW	STW	Control Word
DP	-	Decentralizen Periphery
EIA	-	Electronic Industries Association: Author of the EIA standard RS 485-A
EMC	EMV	Electromagnetic Compatibility
FIFO	-	First In First Out
FMS	-	Fieldbus Message Specification
Hd	-	Hammind Distance
HPFB	-	High Performance Field Bus
IND	-	Subindex
I/O	E/A	Input/Output
ISO	-	International Standards Organization
LSB	-	Lowest Significant Bit
MSB	-	Most Significant Bit
MAP	-	Manufacturing Automation Protocol
MAV	HIW	Main Actual Value
MMS	-	Manufacturing Message Specification
MRV	HSW	Main Reference Value
OD	OV	Object Directory
PC	-	Personal Computer
PCA	PKE	Parameter Characteristics
PCD	PZD	Process Data
PCV	PKW	Parameter Characteristics Value
PDU	-	Protocol Data Unit
PLC	SPS	Programmable Logic Control
PNU	-	Parameter Number
PPO	-	Parameter Process Data Object
PVA	PWE	Parameter Value
RC	AK	Request/Response Characteristics
SPM	-	Spontaneous Message
STW	ZSW	Status Word
TSDR	-	Station Delay
TRT	-	Target Rotation Time
VDE	-	Verein Deutscher Elektrotechniker
VDI	-	Verein Deutscher Elektroingenieure

Status word

According to FC standard	28
According to Profdriveprofile.....	25
STW	31
SYNC	22

T

Time behaviour during system update	16
---	----

U

UNFREEZE.....	22
UNSYNC	22

V

VLT frequency converter parameters	35
--	----

W

WARN. 34	43
Warnings:	43

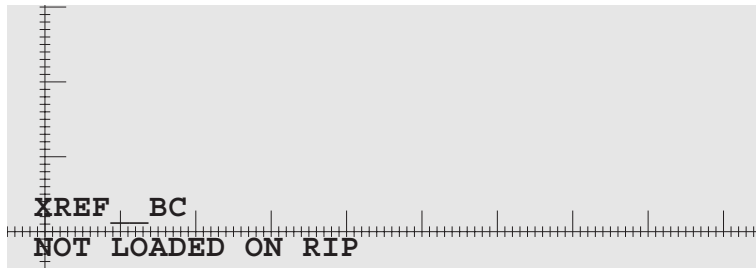

VLT® 5000 / 5000 FLUX / 6000 HVAC / 8000 AQUA



Operating Instructions

VLT® frequency converters **BAUER** geared motors

Danfoss can accept no responsibility for possible errors in catalogues, brochures and other printed material. Danfoss reserves the right to alter its products without notice. This also applies to products already on order provided that such alterations can be made without subsequential changes being necessary in specifications already agreed. All trademarks in this material are property of the respective companies. Danfoss and the Danfoss logotype are trademarks of Danfoss A/S. All rights reserved.

