

Contents

Safety Note	3
Introduction	4
About this Manual	4
Technical Overview	5
Assumptions	5
Hardware	5
Background Knowledge	5
FC 300-related Literature	5
ODVA Conformance	5
Abbreviations	6
How to Install.....	7
The EtherNet/IP Option.....	7
How to Install Option in Frequency Converter.....	8
LED Behaviour	9
Topology.....	10
Network.....	11
Recommended Design Rules	12
EMC Precautions.....	13
How to Configure the System.....	14
IP Settings	14
Ethernet Link Parameters	16
Configuring the Scanner.....	17
IP traffic.....	19
How to Control the FC 300	20
I/O Assembly Instances	20
EtherNet/IP connections.....	21
Control Word Profile	23
Change of State, COS.....	23
Danfoss FC Control Profile	24
ODVA Control Profile	28
Reference Handling	30
Parameters	32
Parameter List.....	43
Data Types Supported by FC 300	44
Troubleshooting	45
Step-by-step troubleshooting	45
Alarm Word and Warning Word	46
Appendix	51
Supported CIP Objects.....	51
Index	60

Copyright, Limitation of Liability and Revision Rights

This publication contains information proprietary to Danfoss A/S. By accepting and using this manual the user agrees that the information contained herein will be used solely for operating equipment from Danfoss A/S or equipment from other vendors provided that such equipment is intended for communication with Danfoss equipment over an Ethernet serial communication link. This publication is protected under the Copyright laws of Denmark and most other countries.

Danfoss A/S does not warrant that a software program produced according to the guidelines provided in this manual will function properly in every physical, hardware or software environment.

Although Danfoss A/S has tested and reviewed the documentation within this manual, Danfoss A/S makes no warranty or representation, either express or implied, with respect to this documentation, including its quality, performance, or fitness for a particular purpose.

In no event shall Danfoss A/S be liable for direct, indirect, special, incidental, or consequential damages arising out of the use, or the inability to use information contained in this manual, even if advised of the possibility of such damages. In particular, Danfoss A/S is not responsible for any costs including but not limited to those incurred as a result of lost profits or revenue, loss or damage of equipment, loss of computer programs, loss of data, the costs to substitute these, or any claims by third parties.

Danfoss A/S reserves the right to revise this publication at any time and to make changes in its contents without prior notice or any obligation to notify previous users of such revisions or changes.

Safety Note



The voltage of the frequency converter is dangerous whenever connected to mains. Incorrect installation of the motor, frequency converter or fieldbus may cause damage to the equipment, serious personal injury or death. Consequently, the instructions in this manual, as well as national and local rules and safety regulations, must be complied with.

Safety Regulations

1. The frequency converter must be disconnected from mains if repair work is to be carried out. Check that the mains supply has been disconnected and that the necessary time has passed before removing motor and mains plugs.
2. The [OFF] key on the control panel of the frequency converter does not disconnect the equipment from mains and is thus not to be used as a safety switch.
3. Correct protective earthing or grounding of the equipment must be established, the user must be protected against supply voltage, and the motor must be protected against overload in accordance with applicable national and local regulations.
4. The earth leakage currents are higher than 3.5 mA.
5. Protection against motor overload is not included in the factory setting. If this function is desired, set par. 1-90 to data value *ETR trip* or data value *ETR warning*.
Note: The function is initialised at 1.16 x rated motor current and rated motor frequency. For the North American market; the ETR functions provide class 20 motor overload protection in accordance with NEC.
6. Do not remove the plugs for the motor and mains supply while the frequency converter is connected to mains. Check that the mains supply has been disconnected and that the necessary time has passed before removing motor and mains plugs.
7. Please note that the frequency converter has more voltage inputs than L1, L2 and L3, when load sharing (linking of DC intermediate circuit) and external 24 V DC have been installed. Check that all voltage inputs have been disconnected and that the necessary time has passed before commencing repair work.

Warning against Unintended Start

1. The motor can be brought to a stop by means of digital commands, bus commands, references or a local stop, while the frequency converter is connected to mains.
If personal safety considerations make it necessary to ensure that no unintended start occurs, these stop functions are not sufficient.
2. While parameters are being changed, the motor may start. Consequently, the [OFF] key must always be activated.
3. A motor that has been stopped may start if faults occur in the electronics of the frequency converter, or if a temporary overload or a fault in the supply mains or the motor connection ceases.



Warning:

Touching the electrical parts may be fatal - even after the equipment has been disconnected from mains.

Also make sure that other voltage inputs have been disconnected, such as external 24 V DC, load sharing (linkage of DC intermediate circuit), as well as the motor connection for kinetic back up.

Please take note of discharge times and further safety guidelines from the section: "Safety and conformity", in the respective Design Guide (MG.33.Ax.yy).

Introduction

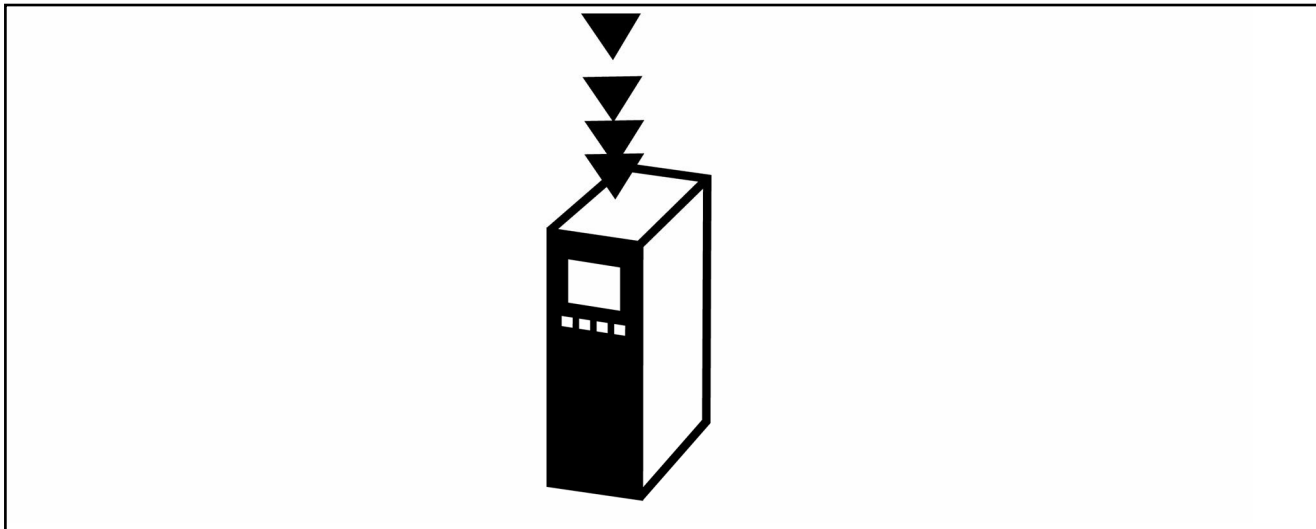

About this Manual

First time users can obtain the most essential information for quick installation and set-up in these chapters:

Introduction

How to Install

How to Configure the System

For more detailed information including the full range of set-up options and diagnosis tools please refer to the chapters:

How to Configure the System

How to Control the FC 100/200/300

How to Access FC 100/200/300 Parameters

Parameters

Troubleshooting

Terminology:

In this manual several terms for Ethernet is used.

- **EtherNet/IP**, is the term used to describe the CIP/ODVA application protocol.
- **Ethernet**, is a common term used to describe the physical layer of the network and does not relate to the application protocol.

Technical Overview

EtherNet/IP™ was introduced in 2001 and today is the most developed, proven and complete industrial Ethernet network solution available for manufacturing automation.

EtherNet/IP is a member of a family of networks that implements the Common Industrial Protocol (CIP™) at its upper layers. CIP encompasses a comprehensive suite of messages and services for a variety of manufacturing automation applications, including control, safety, synchronization, motion, configuration and information. As a truly media-independent protocol that is supported by hundreds of vendors from around the world, CIP provides users with unified communication architecture throughout the manufacturing enterprise.

EtherNet/IP provides users with the network tools to deploy standard Ethernet technology for manufacturing applications while enabling Internet and enterprise connectivity.

Assumptions

These operating instructions are under the conditions that the Danfoss EtherNet/IP option is used in conjunction with a Danfoss FC 100/200/300 frequency converter, inclusive that the installed controller supports the interfaces described in this document and that all the requirements stipulated in the controller, as well as the frequency converter, are strictly observed along with all limitations herein.

Hardware

This manual relates to the EtherNet/IP option MCA121, type no. 130B1119 (un-coated) and 130B1219 (coated).

Background Knowledge

The Danfoss EtherNet/IP Option Card is designed to communicate with any system complying with the CIP EtherNet/IP standard. Familiarity with this technology is assumed.

Issues regarding hardware or software produced by other manufacturers, including commissioning tools, are beyond the scope of this manual, and are not the responsibility of Danfoss.

For information regarding commissioning tools, or communication to a non-Danfoss node, please consult the appropriate manuals.

FC 300-related Literature

The following literature is available for the FC 300 series:

Title	Literature no.
FC 300 Operating Instructions	MG.33.Ax.yy
FC 300 Design Guide	MG.33.Bx.yy

Please also refer to:

<http://www.danfoss.com/BusinessAreas/DrivesSolutions/>

-for additional information.

ODVA Conformance

The EtherNet/IP option is tested to conform to the ODVA standards, and is certified, towards conformance test level version 3.

Abbreviations

API	Actual Packet Interval	MSB	Most Significant Bit
CC	Control Card	MRV	Main Reference Value
CIP	Common Industrial Protocol	N/A	Not applicable
CTW	Control Word	ODVA	Open DeviceNet Vendor Association
DHCP	Dynamic Host Configuration Protocol	PC	Personal Computer
EIP	EtherNet/IP	PLC	Programmable Logic Controller
EMC	Electromagnetic Compatibility	PNU	Parameter NUmber
I/O	Input/Output	REF	Reference (= MRV)
IP	Internet Protocol	RTC	Real Time Clock
LCP	Local Control Panel	STP	Spanning tree Protocol
LED	Light Emitting Diode	STW	Status Word
LSB	Least Significant Bit		
MAR	Major Recoverable fail		
MAU	Major Unrecoverable fail		
MAV	Main Actual Value (actual output)		

How to Install

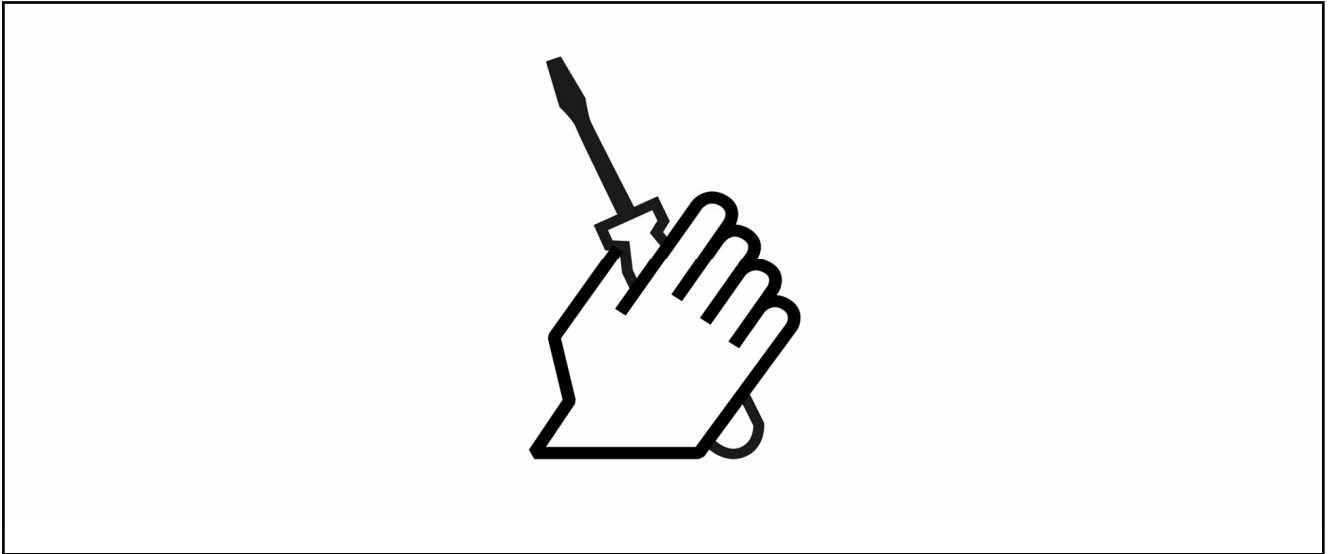

The EtherNet/IP Option

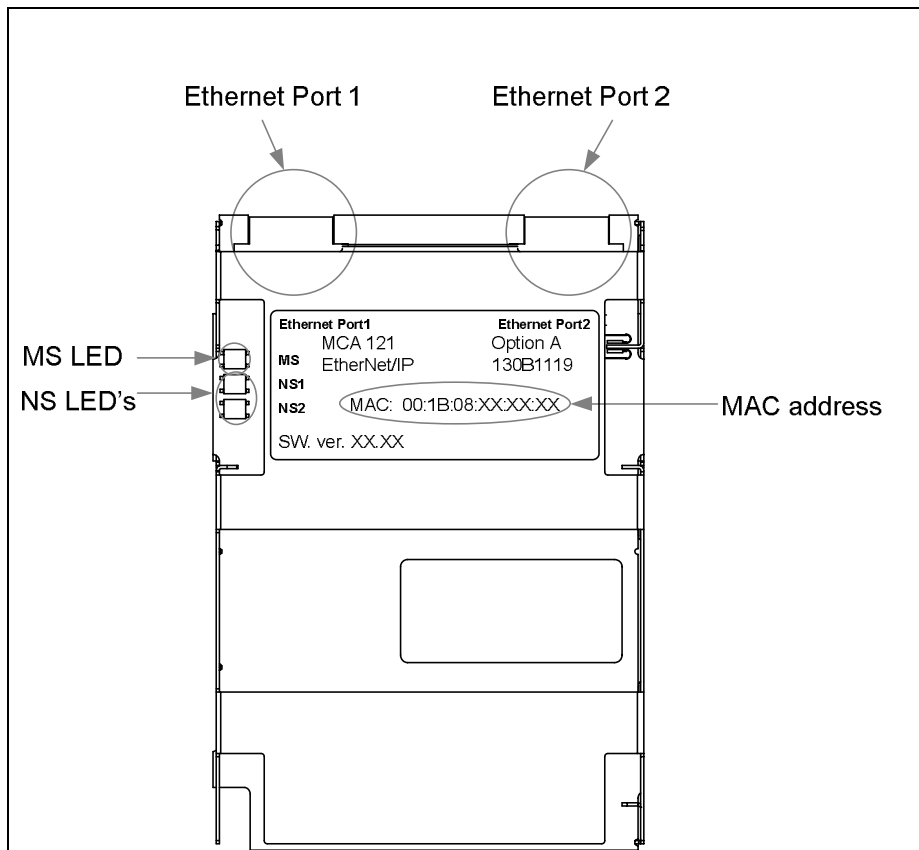

How to Install Option in Frequency Converter

Items required for installing a fieldbus option in the frequency converter:

- The fieldbus option
- Fieldbus option adaptor frame for the FC 100/200/300. This frame is deeper than the standard frame, to allow space for the fieldbus option beneath
- Strain relief (only for A1 and A2 enclosures)

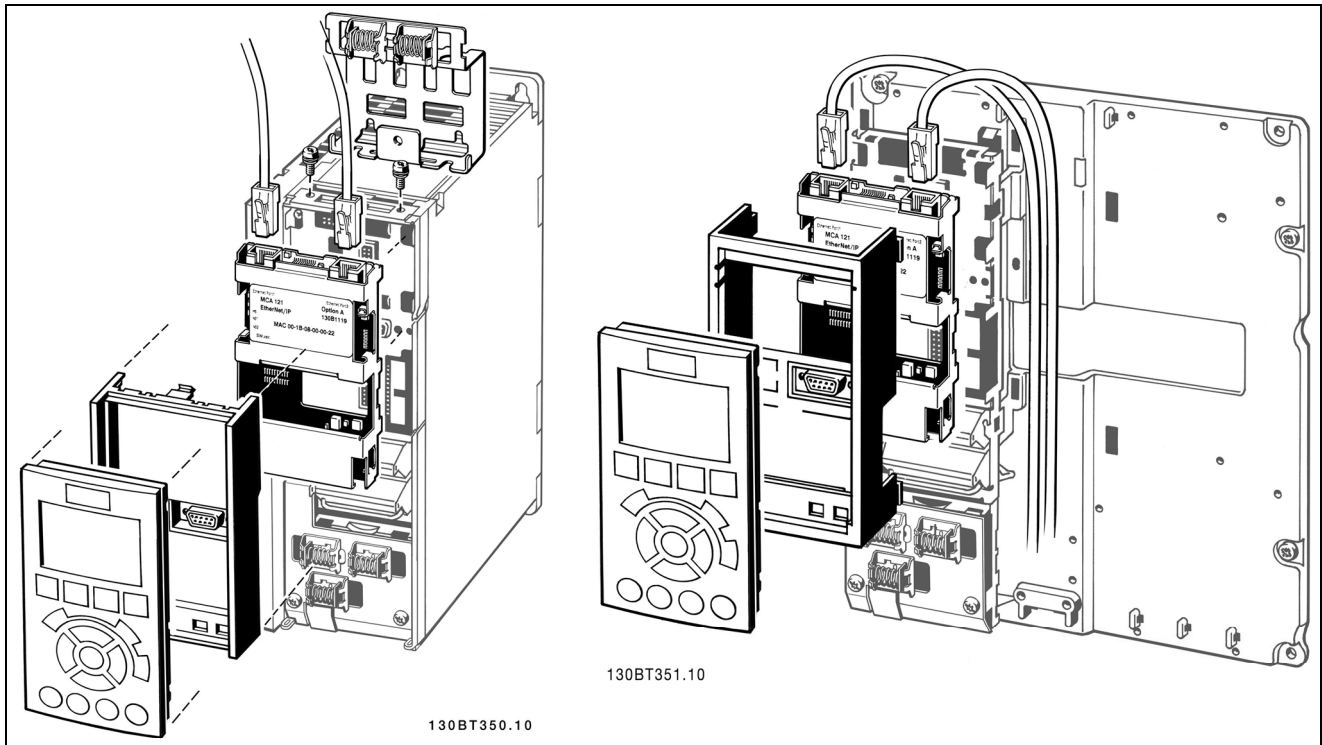

Instructions:

- Remove LCP panel from the FC 100/200/300.
- Remove the frame located beneath and discard it.
- Push the option into place. The Ethernet connectors must be facing upwards.
- Remove both knock-outs on the fieldbus option adaptor frame.
- Push the fieldbus option adaptor frame for the FC 100/200/300 into place.
- Replace the LCP and attach cable



N.B.:

Do not strip the Ethernet cable and ground it via the strain relief-plate!
The grounding of screened Ethernet cable is done through the RJ-45 connector on the option.



N.B.:

After installing the MCA121 option, be aware of the following parameter settings:

Par. 8-01 Control Site [2] Controlword only or [0] Digital and ctrl. word
Par. 8-02 Control Word Source [3] Option A







LED Behaviour

The option has 3 bi-coloured LED's according to ODVA specifications:







LED label	Description
MS	Module Status
NS1	Network Status Ethernet Port 1
NS2	Network Status Ethernet Port 2

The option LED's operates according to ODVA specifications.

MS: Module Status

State	LED	Description
No power	Off	The device is un-powered
Device operational	Green: 	Solid green
Standby	Green: 	Flashing green
Minor fault	Red: 	Flashing red
Major fault	Red: 	Solid red
Self test	Red:  Green: 	Flashing red/green

NS1 + NS2: Network status (one per port)

State	LED	Description
No IP-address (no power)	Off	The device does not have a valid IP-address (or is un-powered)
No connections	Green: 	Flashing green
Connected	Green: 	Steady green
Connection time-out	Red: 	Flashing red
Duplicate IP	Red: 	Steady red
Self test	Red:  Green: 	Flashing red/green

During normal operation the MS and at least one NS LED will show a constant green light.

Topology

The MCA121 features a build-in Ethernet-switch, thus having two Ethernet RJ-45 connectors. This enables the possibility for connecting several EtherNet/IP options in a line topology as an alternative to the typical star-topology.

The two ports are equal, in the sense that they are transparent for the option. If only one connector is used, either port can be used.

Star topology

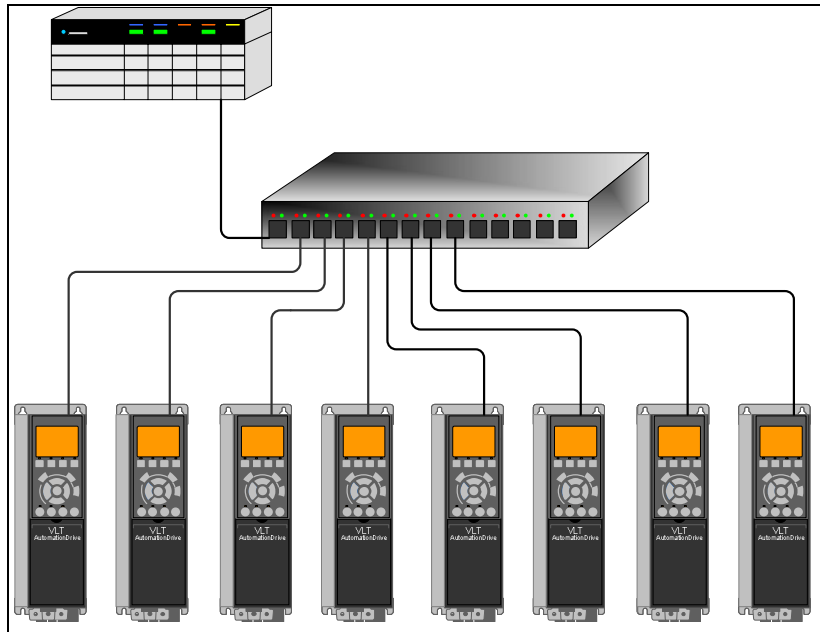

Line topology

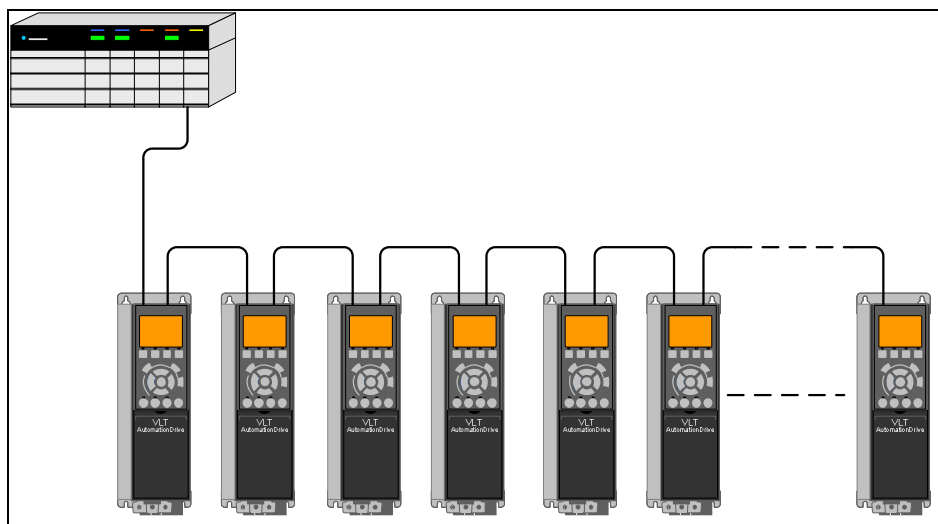

Note: For line topology please refer to section: "Recommended design rules"
 In a line topology all drives must be powered, either by mains or by their 24 V DC option cards, for the build-in switch to work.

Ring/redundant line topology

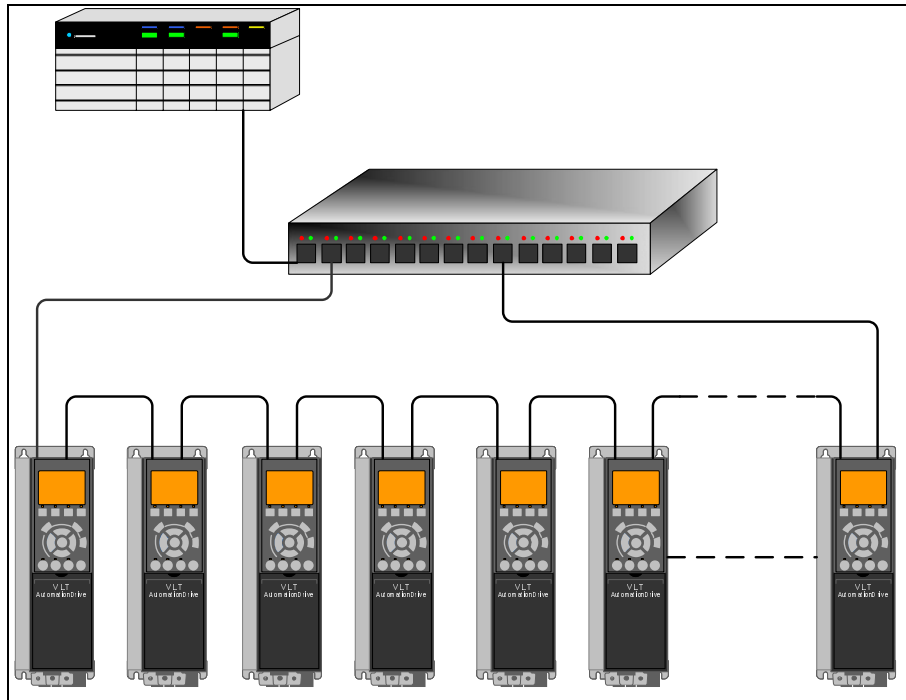

N.B.: For this type of topology it is crucial that the network switch supports Spanning Tree Protocol (STP), and that STP is enabled.
For more information on Spanning Tree please refer to section *IP traffic*.

Network

It is of high importance that the media chosen for Ethernet data transmission are suitable. Usually CAT 5e and 6 cables are recommended for industrial applications. Both types of cable are available as Unshielded Twisted Pair and Shielded Twisted Pair. Generally shielded cables are recommended for use in industrial environments and with frequency converters. A maximum cable-length of 100 m is allowed between switches.

Optical fibres can be used for gapping longer distances and providing galvanic isolation.

For connecting EtherNet/IP devices both hubs and switches can be used. It is, however, recommended always to use suitable industrial graded Ethernet switches. For more information regarding IP-switching, please refer to section: *IP Traffic* in this manual.

Recommended Design Rules

While designing Ethernet networks special attention and caution must be taken regarding active network components.

While designing a network for line topology it is important to notice that a small delay is added with each every switch in the line.

For EtherNet/IP the maximum number of drives in a line is dependent of the API speed of the connected scanner:

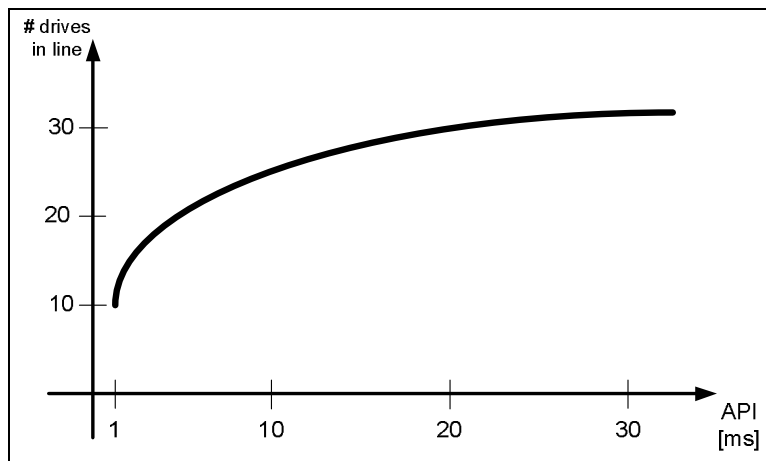

According to the graph above, the network should thus be segmented with the use of external Ethernet switches.

It is not recommended to connect more than 32 drives in a line at any API.

Exceeding the recommended design rules, may result in failing communication.

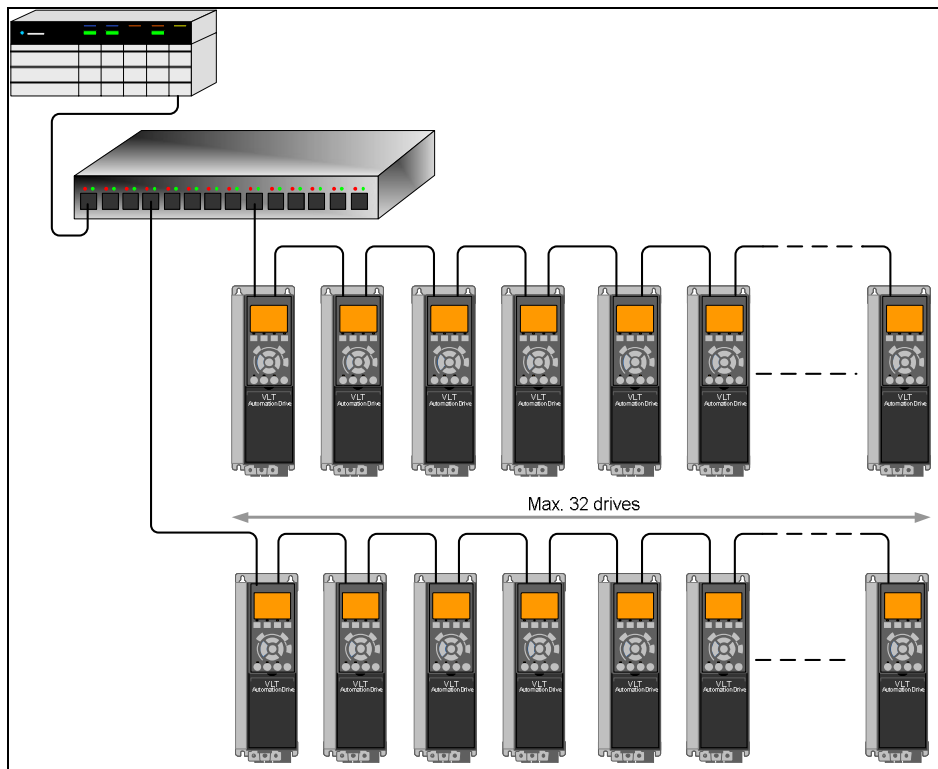

EMC Precautions

The following EMC precautions are recommended in order to achieve interference-free operation of the Ethernet network. Additional EMC information is available in the FC 100/200/300 series Design Guide.

**N.B.:**

Relevant national and local regulations, for example regarding protective earth connection, must be observed.

The Ethernet communication cable must be kept away from motor and brake resistor cables to avoid coupling of high frequency noise from one cable to the other. Normally a distance of 200 mm (8 inches) is sufficient, but maintaining the greatest possible distance between the cables is recommended, especially where cables run in parallel over long distances. When crossing is unavoidable, the Ethernet cable must cross motor and brake resistor cables at an angle of 90 degrees.

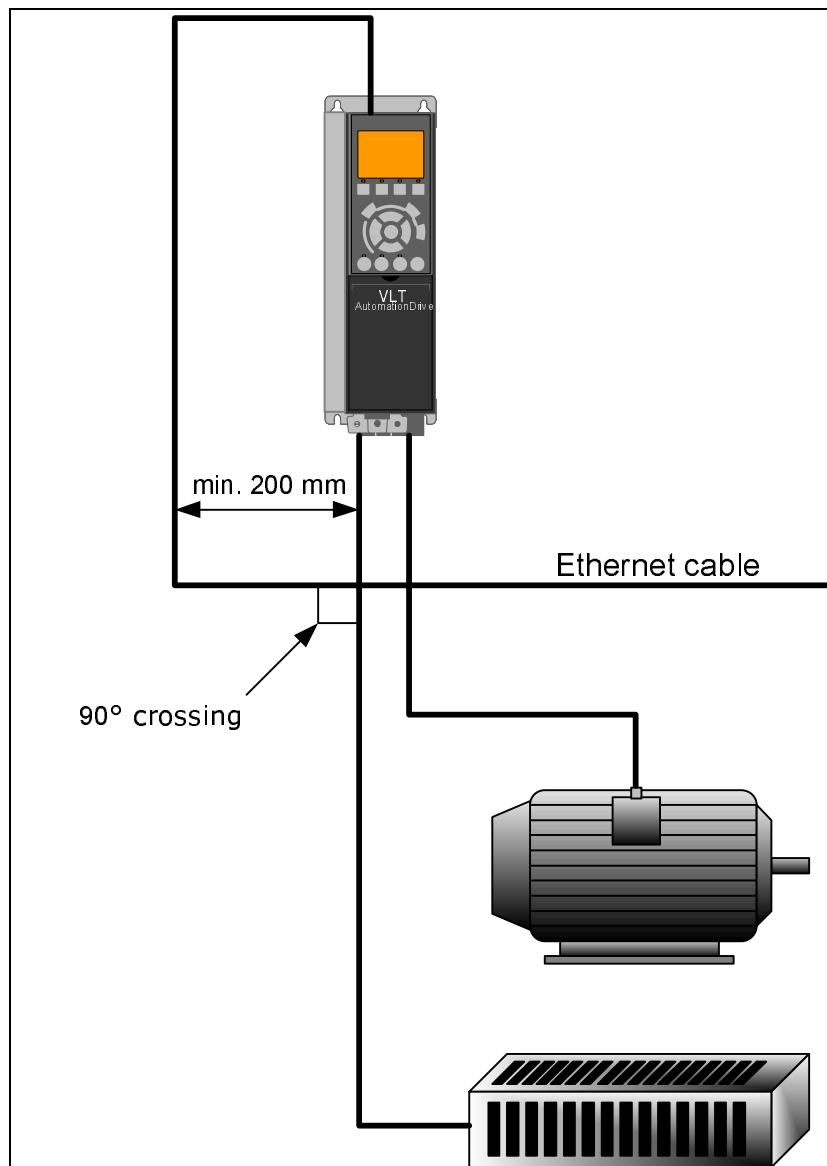

How to Configure the System

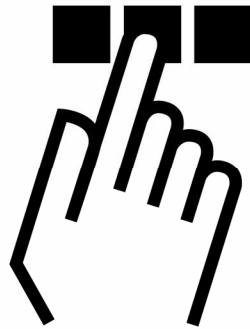

IP Settings

All IP-related parameters are located in parameter group 12-0*:

12-00	IP Address Assignment	12-05	Lease Expires
12-01	IP Address	12-06	Name Servers
12-02	Subnet Mask	12-07	Domain Name
12-03	Default Gateway	12-08	Host Name
12-04	DHCP Server	12-09	Physical Address

The MCA121 option offers several ways of IP address assignment.

Setting up drive with manual assigned IP address:

Par.	Name	Value
12-00	<i>IP Address Assignment</i>	[0] MANUAL
12-01	<i>IP Address</i>	192.168.0.xxx*
12-02	<i>Subnet Mask</i>	255.255.255.0*
12-03	<i>Default Gateway</i>	<i>optional</i>

*= Class C IP address example. Any valid IP address can be entered.



N.B.:

A power-cycle is necessary after setting the IP parameters manually.

Setting up drive with automatic (BOOTP/DHCP) assigned IP address:

Par.	Name	Value
12-00	<i>IP Address Assignment</i>	[1] DHCP/[2] BOOTP
12-01	<i>IP Address</i>	Read only
12-02	<i>Subnet Mask</i>	Read only
12-03	<i>Default Gateway</i>	Read only

By IP address assigned by DHCP/BOOTP server, the assigned *IP Address* and *Subnet Mask* can be read out in par. 12-01 and 12-02.

In par. 12-04 *DHCP Server*, the IP address of the found DHCP or BOOTP server is displayed.

For DHCP only: The remaining lease-time can be read-out in par. 12-05 *Lease Expires*.

Par. 12-09 *Physical Address* reads out the MAC address of option, which is also printed on the label of the option. If using fixed leases together with DHCP or BOOTP, the physical MAC address is linked with a fixed IP address.



N.B.:

If no DHCP or BOOTP reply has been received after 4 attempts (e.g. if the DHCP/BOOTP server has been powered off), the option will fallback to the last good known IP address.

Par. 12-03 *Default Gateway* is optional and only used in routed networks.

Par. 12-06 *Name Servers*

Par. 12-07 *Domain Name*

Par. 12-08 *Host Name*

Are used with Domain Name Server systems and are all optional. If DHCP or BOOTP is selected as IP address assignment, these parameters are read only.



N.B.:

It is only possible to assign valid class A, B and C IP address to the option.
The valid ranges are:

Class A	1.0.0.1 - 126.255.255.254
Class B	128.1.0.1 - 191.255.255.254
Class C	192.0.1.1 - 223.255.254.254

Ethernet Link Parameters

Parameter group 12-1* holds information Ethernet Link information:

12-10	Link Status
12-11	Link Duration
12-12	Auto Negotiation
12-13	Link Speed
12-14	Link Duplex

Please note the Ethernet Link Parameters are unique per port.

Par. 12-10 Link Status and par. 12-11 Link Duration displays information on the link status, per port.

Par. 12-10 *Link Status* will display *Link* or *No Link* according to the status of the present port.

Par. 12-11 *Link Duration* will display the duration of the link on the present port. If the link is broken the counter will be reset.

Par. 12-12 Auto Negotiation – is a feature that enables two connected Ethernet devices to choose common transmission parameters, such as speed and duplex mode. In this process, the connected devices first share their capabilities as for these parameters and then choose the fastest transmission mode they both support.

By default this function is enabled.

Incapability between the connected devices, may lead to decreased communication performance.

To prevent this Auto Negotiation can be disabled.

If par. 12-12 is set to OFF, link speed and duplex mode can be configured manually in par. 12-13 and 12-14.

Par. 12-13 Link Speed – displays/sets the link speed per port. “None” is displayed if no link is present.

Par. 12-14 Link Duplex – displays/sets the duplex mode per port.

Half-duplex provides communication in both directions, but only in one direction at a time (not simultaneously).

Full-duplex allows communication in both directions, and unlike half-duplex, allows for this to happen simultaneously.

Configuring the Scanner

EDS file

Danfoss Drives provides a generic English EDS (Electronic Data Sheet) file covering all voltage and power sizes, for off-line configuration.

The EDS file can be downloaded from:

http://www.danfoss.com/BusinessAreas/DrivesSolutions/SoftwareDownload/DDFieldbus_Setup_Files.htm



N.B.:

The current version of the major EtherNet/IP configuration tools does not support EDS-files for EtherNet/IP devices.

Configuring a Rockwell Master

For configuring a FC 100/200/300 with MCA121 for operation with a Rockwell (Allen-Bradley) Scanner via EtherNet/IP, the FC 100/200/300 must be added as a *Generic Ethernet Module*.

Under the *General* -tab, enter information about: Name of device, IP Address, Assembly Instance and Data size.

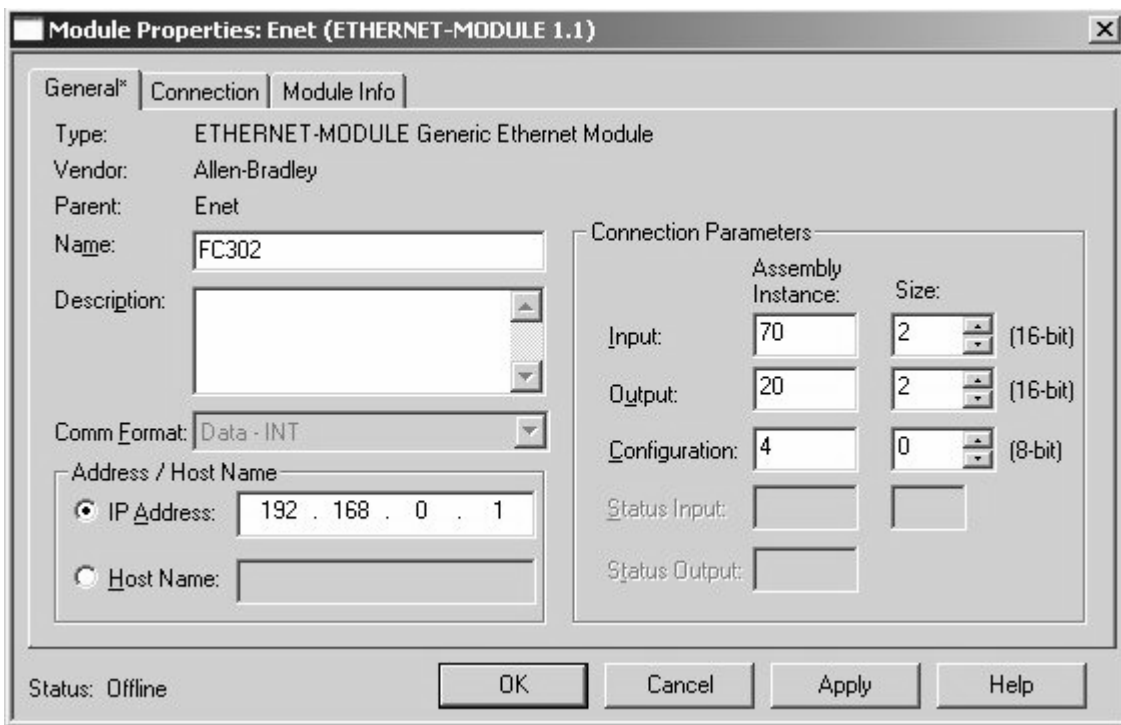

Module Properties: Enet (ETHERNET-MODULE 1.1)

General* | Connection | Module Info

Type: ETHERNET-MODULE Generic Ethernet Module
 Vendor: Allen-Bradley
 Parent: Enet
 Name: FC302
 Description:
 Comm_Format: Data - INT

Address / Host Name
 IP Address: 192 . 168 . 0 . 1
 Host Name:

Connection Parameters

	Assembly Instance:	Size:	
Input:	70	2	(16-bit)
Output:	20	2	(16-bit)
Configuration:	4	0	(8-bit)
Status Input:			
Status Output:			

Status: Offline

OK Cancel Apply Help



N.B.:

Under *Configuration* in the Connection Parameters a "4" must be entered as Assembly Instance.

Under the *Connection* Tab, enter information about: RII and fault conditions.

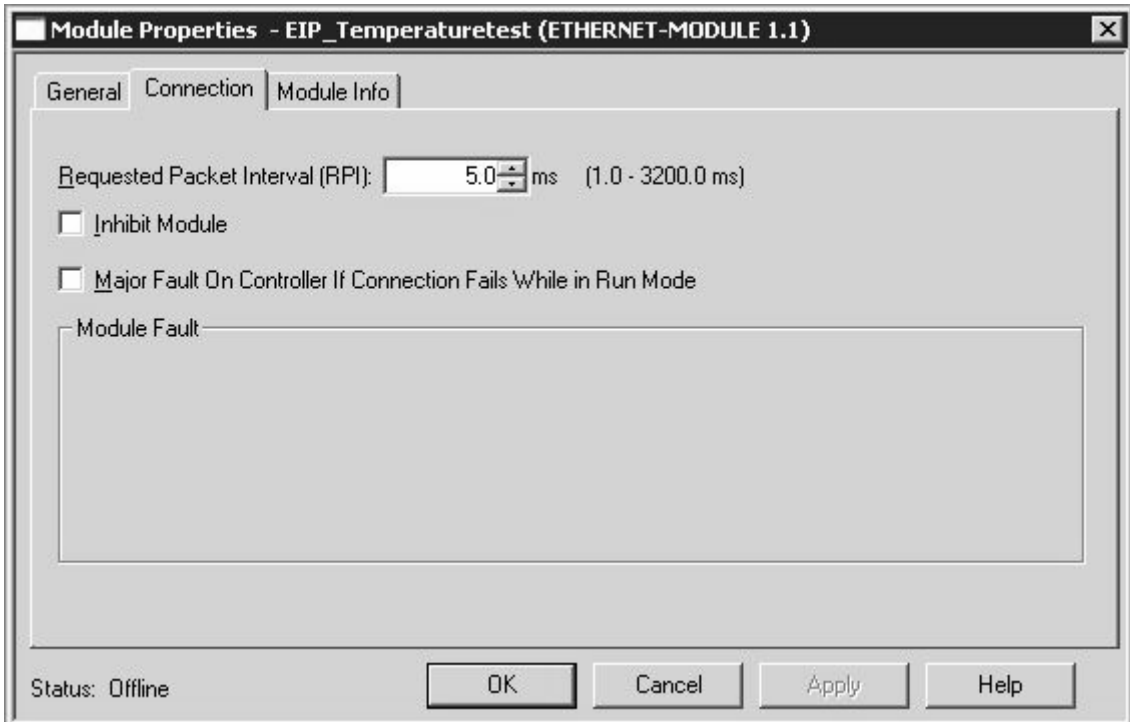

The *Module Info* – This tap holds generic information.
 The *Reset Module* – This button will make a simulated Power-cycle of the drive.

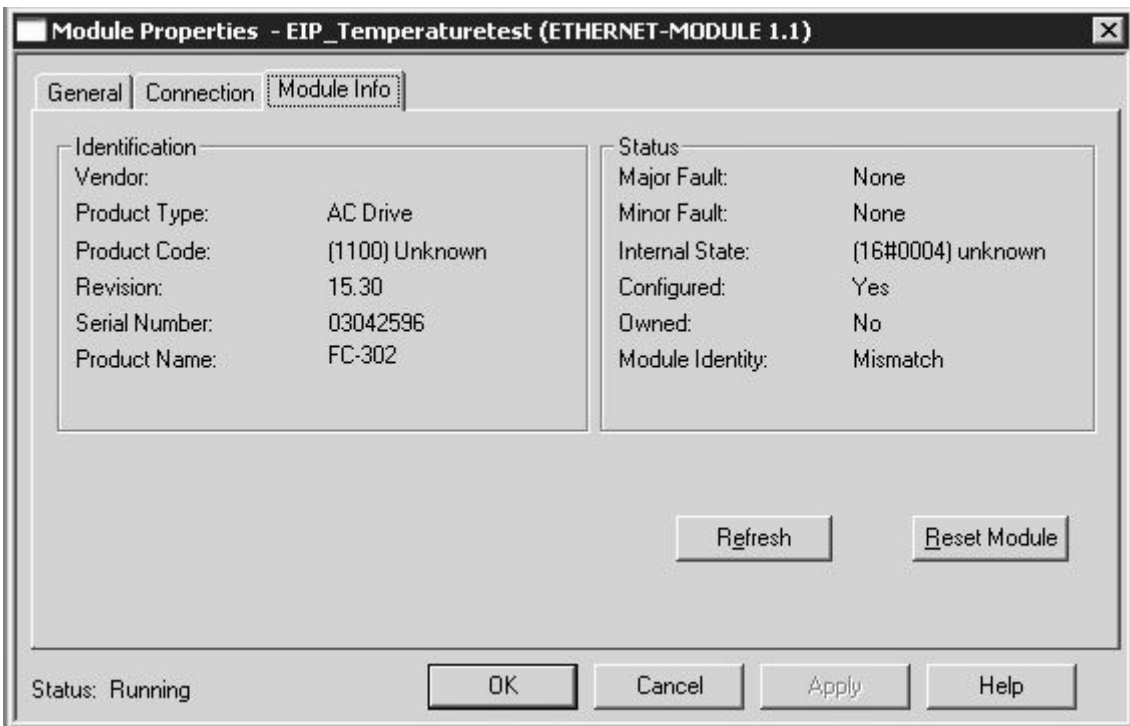

N.B.: For more information on the CIP class 1 Forward Open command, please refer to section: *EtherNet/IP Connections* under the *How to Control* -chapter.

IP traffic

The use of Ethernet based network for industrial automation purposes, calls for careful and thorough network design.

Especially the use of active network components like switches and routers requires detailed know-how about the behaviour of IP traffic.

Some important issues:

Multicast

Multicast traffic; is traffic that is addressed to **a number of** recipients.

Each host processes the received multicast packet to determine if it is the target for the packet. If not, the IP package is discarded.

This causes an excessive network load of each node in the network since they are flooded with multicast packages.

The nature of EtherNet/IP traffic is that all Originator-to-Target traffic is Unicast (point-to-point) but Target-to-Originator traffic is optional Multicast.

This enables that several *listen only* -connections can be made to a single host.

In switched networks hosts also have the risk of becoming flooded with multicast traffic.

A switch usually forwards traffic by MAC address tables build by looking into the source address field of all the frames it receives.

A multicast MAC address is never used as a source address for a packet. Such addresses do not appear in the MAC address table, and the switch has no method for learning them, so it will just forward all multicast traffic to all connected hosts.

IGMP

IGMP (Internet Group Management Protocol) is an integrated part of IP.

It allows hosts to join or leave a multicast host group. Group membership information is exchanged between a specific host and the nearest multicast router.

For EtherNet/IP networks it is essential that the switches used, supports **IGMP Snooping**.

IGMP Snooping enables the switch to "listen in" on the IGMP conversation between hosts and routers. By doing this the switch will recognise which hosts are members of which groups, thus being able to forward multicast traffic only to the appropriate hosts.

Spanning Tree Protocol (STP)

For an Ethernet network to function properly, only one active path can exist between two nodes.

Spanning-Tree Protocol is a link management protocol that provides path redundancy while preventing undesirable loops in the network.

When loops occur, some switches see stations appear on both sides of it self. This condition confuses the forwarding algorithm and allows for duplicate frames to be forwarded.

To provide path redundancy, Spanning-Tree Protocol defines a tree that spans all switches in an extended network. Spanning-Tree Protocol forces certain redundant data paths into a standby (blocked) state. If one network segment in the Spanning-Tree Protocol becomes unreachable, or if Spanning-Tree Protocol costs change, the spanning-tree algorithm reconfigures the spanning-tree topology and re-establishes the link by activating the standby path.

Spanning-Tree Protocol operation is necessary if the FC 100/200/300's are running in a ring/redundant line topology.

How to Control the FC 100/200/300

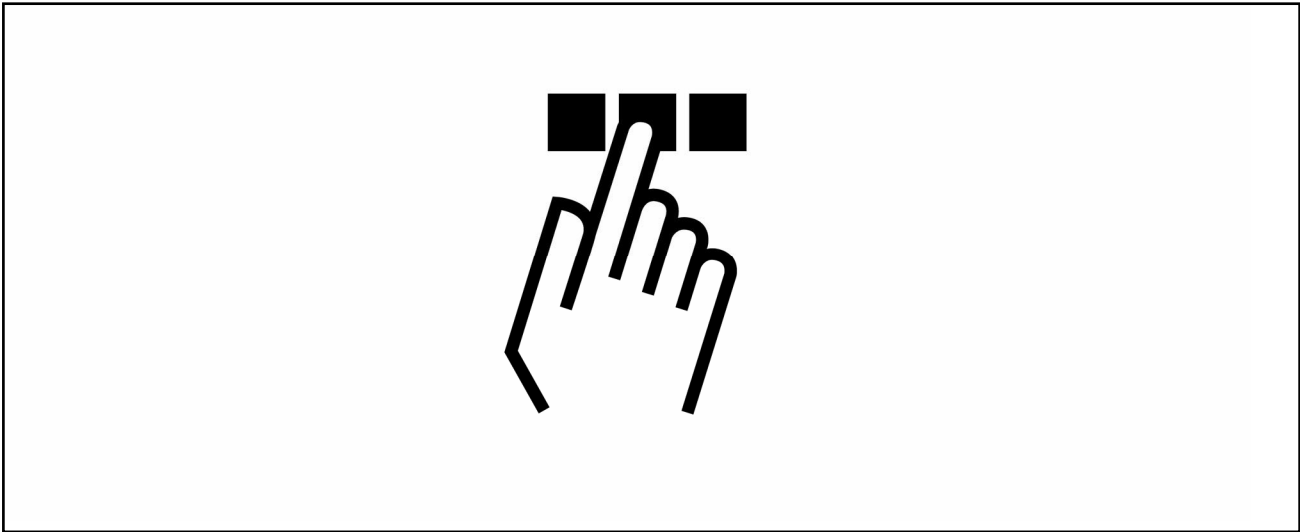

I/O Assembly Instances

I/O Assembly Instances are a number of defined process control objects with defined content comprising control and status information.

Unlike DeviceNet it is possible to run with asymmetrical instances. E.g. 101/153 = 8 bytes/20 bytes.

It is not possible to mix instances across profiles, e.g. 20/100.
 Assembly instances must be consistent to the: ODVA or FC profile.

The controlling instance can be read in par. 12-20 *Control Instance*.

The figure below shows the I/O Assembly Instance options for controlling and monitoring the FC 100/200/300 drive.

Profile (par. 8-10)	Direction	Instance (decimal)	Size (bytes)	Data
ODVA	Originator -> Target	20	4	CTW (20) REF
		21	4	CTW (21) REF
	Target -> Originator	70	4	STW (70) MAV
		71	4	STW (71) MAV
FC	Originator -> Target	100	4	CTW (FC) REF
		101	8	CTW (FC) REF PCD [2] PCD [3]
		103	20	CTW (FC) REF PCD [2] PCD [9]
	Target -> Originator	150	4	STW (FC) MAV
		151	8	STW (FC) MAV PCD [2] PCD [3]
		153	20	STW (FC) MAV PCD [2] PCD [9]

**N.B.: Use of 32-bit process data.**

For configuration of a 2-word (32-bit) parameter read/write, use 2 consecutive arrays in par. 12-21 and 12-22, like [2]+[3], [4]+[5], [6]+[7] etc.

Read/write of 2-word values in arrays like: [3]+[4], [5]+[6], [7]+[8] are not possible.

EtherNet/IP connections

The MCA121 option supports the following CIP connections:

Class 1 connection

I/O connection using TCP transport.

Maximum one Class 1 connection is supported by the EtherNet/IP option, but several listen only connection can be established if multicast is selected as Transport type.

This type of connection is used for cyclic I/O and Change-Of-State connections. The connection is established with a **Forward Open** command, containing the following information:

Transport Type:

Specified for both directions: Originator-to-Target / Target-to-Originator.

- Point to Point
- Multicast (Target-to-Originator only)

Data Size:

Specified (in bytes) for both directions: Originator -> Target / Target -> Originator.

The data-size depends on the assembly-instance chosen in: *Destination*.

Instances (decimal):		Data size:
Originator -> Target	Target -> Originator	
20, 21, 100	70, 71, 150	4 bytes
101	151	8 bytes
103	153	20 bytes

Packet Rate:

Specified (in milliseconds) for both directions: Originator -> Target / Target -> Originator.

Minimum packet rate supported: **1 ms**

Production inhibit timeout:

Specifies (in milliseconds) the timeout-time for both directions.

Trigger:

Selects the transport trigger type:

- Cyclic (Data is transmitted cyclically as polled I/O).
- Change Of State (Data is transmitted on Change of State only. COS-filters are set-up in par. 12-38 *COS Filters*)

Connection points:

Specified for both directions: Originator -> Target / Target -> Originator.

Profile (par. 8-10)	Direction	Connection points (decimal)
ODVA	Originator -> Target	20, 21
	Target -> Originator	70, 71
FC	Originator -> Target	100, 101, 103
	Target -> Originator	150, 151, 153

Class 3 connection

Cyclic connection using UDP transport.

Maximum 6 Class 3 connections are supported.

This type of connection is used for explicit messaging. The connection is established with a Forward Open command, containing the following information:

Connection Name:

Given name for the connection

Message Parameters:

- Service Code
- Class
- Instance
- Attribute
- Member
- Request Data

Unconnected Messages, UCMM

Non-cyclic (single) connection using TCP transport.

This type of connection is used for explicit messaging. The connection is established on-the-fly and does not require any Forward Open command.

Message Parameters:

- Service Code
- Class
- Instance
- Attribute
- Member
- Request Data

Please refer to section Appendix for information on accessing CIP objects explicitly.

Control Word Profile

The Control profile is selected in par. 8-10 *Control Word Profile*.

- ODVA; gives access to the ODVA specific profiles and assembly instances: 20, 21, 70 and 71.
- FC; enables the Danfoss profile and assembly instances: 100, 101, 103, 150, 151 and 153.

For more information on the different profiles, please refer to the subsequent sections.



N.B.: Change of control profile.

It is only possible to change the Control profile while the drive is stopped.

Control word and reference will not be recalculated to match the selected profile, but are kept at the last good known value.

Change of State, COS

The event controlled operation mode is used to minimize network traffic.

Messages are transmitted only if a defined state or value has changed. The condition for triggering a COS message, is determined by the insertion of COS-filters (par. 12-21 to 12-21), for each bit in the different PCD-words.

The filter acts like a logical AND-function: If a bit in the filter is set to "1", the COS-function triggers when there is a change to the corresponding bit for the PCD-word.

Parameter 12-38 can be used to filter out undesired events for COS. If a filter bit is set to 0, the corresponding I/O Instance bit will be unable to produce a COS message.

By default, all bits in the COS filters are set to 0.

In order to signal that the connection has not been interrupted, or the device is not powered off, a Heartbeat Message is transmitted within a specified time interval (Heartbeat Interval). This interval is defined in Attribute Heartbeat Time of the connection object, Class 0x01.

To prevent the device from producing heavy network traffic when a value changes frequently, a Production Inhibit Time is defined in par. 12-37. This parameter defines the minimum time between two COS messages.

If par. 13-37 is set to 0, the Production Inhibit Timer is disabled.

The figure below shows the different PCD's and their corresponding filter parameters.

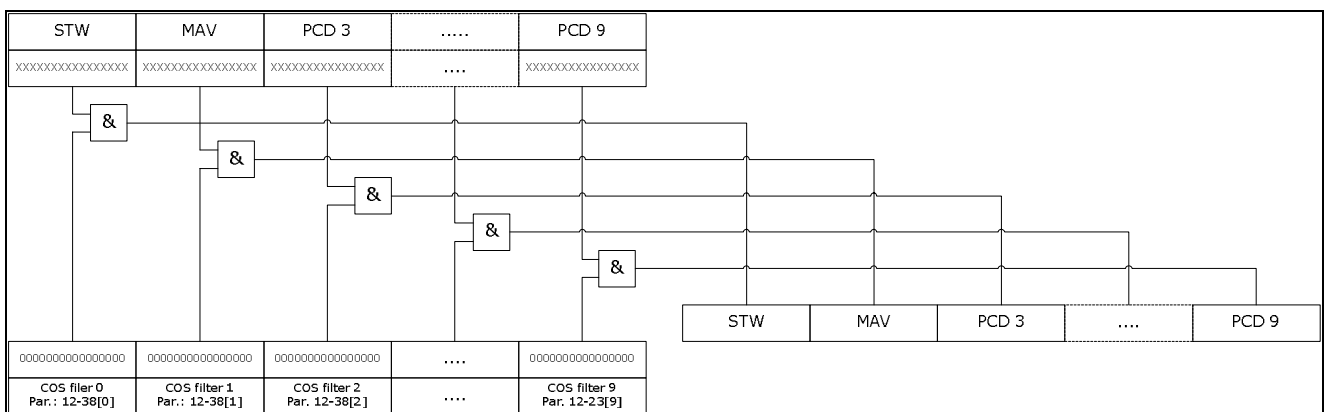

Danfoss FC Control Profile

**Control Word according to FC Profile.
Instances 100, 101, 103/150, 151, 153**

(Par. 8-10 = FC profile)

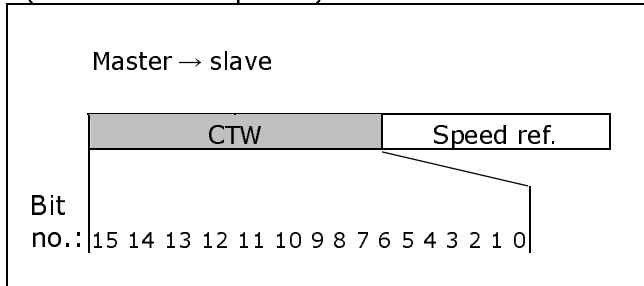

Bit	Bit value = 0	Bit value = 1
00	Reference value	External selection LSB
01	Reference value	External selection MSB
02	DC brake	Ramp
03	Coasting	No coasting
04	Quick stop	Ramp
05	Hold output frequency	Use ramp
06	Ramp stop	Start
07	No function	Reset
08	No function	Jog
09	Ramp 1	Ramp 2
10	Data invalid	Data valid
11	No function	Relay 01 active
12	No function	Relay 04 active
13	Parameter set-up	Selection LSB
14	Parameter set-up	Selection MSB
15	No function	Reverse

Explanation of the Control Bits

Bits 00/01

Bits 00 and 01 are used to choose between the four reference values, which are pre-programmed in par. 3-10 *Preset reference* according to the following table:

Programmed ref. value	Parameter	Bit 01	Bit 00
1	3-10 [0]	0	0
2	3-10 [1]	0	1
3	3-10 [2]	1	0
4	3-10 [3]	1	1

N.B.: In par. 8-56 *Preset reference select* a selection is made to define how Bit 00/01

gates with the corresponding function on the digital inputs.

Bit 02, DC brake:

Bit 02 = '0' leads to DC braking and stop. Braking current and duration are set in par. 2-01 *DC Brake current* and 2-02 *DC Braking time*.

Bit 02 = '1' leads to ramping, par. 3-41

Bit 03, Coasting:

Bit 03 = '0' causes the frequency converter to immediately "let go" of the motor (the output transistors are "shut off"), so that it coasts to a standstill.

Bit 03 = '1' enables the frequency converter to start the motor if the other starting conditions have been fulfilled.

N.B.: In par. 8-50 *Coasting select* a selection is made to define how Bit 03 gates with the corresponding function on a digital input.

Bit 04, Quick stop:

Bit 04 = '0' causes a stop, in which the motor speed is ramped down to stop via par. 3-81 *Quick stop ramp time*.

Bit 05, Hold output frequency:

Bit 05 = '0' causes the present output frequency (in Hz) to freeze. The frozen output frequency can then be changed only by means of the digital inputs (par. 5-10 to 5-15) programmed to *Speed up* and *Speed down*.

N.B.: If *Freeze output* is active, the frequency converter can only be stopped by the following:

- Bit 03 Coasting stop
- Bit 02 DC braking
- Digital input (par. 5-10 to 5-15) programmed to *DC braking*, *Coasting stop* or *Reset and coasting stop*.

Bit 06, Ramp stop/start:

Bit 06 = '0' causes a stop, in which the motor speed is ramped down to stop via the selected *ramp down* parameter.

Bit 06 = '1' permits the frequency converter to start the motor, if the other starting conditions have been fulfilled.

N.B.: In par. 8-53 *Start select* a selection is made to define how Bit 06 Ramp

stop/start gates with the corresponding function on a digital input.

Bit 07, Reset:

Bit 07 = '0' no reset.
 Bit 07 = '1' resets a trip. Reset is activated on the leading edge of the signal, i.e. when changing from logic '0' to logic '1'.

Bit 08, Jog:

Bit 08 = '1' causes the output frequency to be determined by par. 3-19 *Jog speed*.

Bit 09, Selection of ramp 1/2:

Bit 09 = '0' means that ramp 1 is active (par. 3-40 to 3-47). Bit 09 = '1' means that ramp 2 (par. 3-50 to 3-57) is active.

Bit 10, Data not valid/Data valid:

This bit tells the frequency converter whether the control word is to be used or ignored. Bit 10 = '0' causes the control word to be ignored, Bit 10 = '1' causes the control word to be used. The control word is always contained in the telegram, regardless of which type of telegram is used, so this function is useful for 'turning off' the control word when not required for updating or reading parameters.

Bit 11, Relay 01:

Bit 11 = '0' Relay not activated.
 Bit 11 = '1' Relay 01 activated, provided *Control word bit 11* has been chosen in par. 5-40 *Function relay*.

Bit 12, Relay 02:

Bit 12 = '0' Relay 02 has not been activated.
 Bit 12 = '1' Relay 02 has been activated, provided *Control word bit 12* has been chosen in par. 5-40 *Function relay*.

Bit 13/14, Selection of set-up:

Bits 13 and 14 are used to select one of four menu set-ups according to the following table:

Set-up	Bit 14	Bit 13
1	0	0
2	0	1
3	1	0
4	1	1

The function is only possible when *Multi-Set-ups* is selected in par. 0-10 *Active Set-up*.



N.B.:

In par. 8-55 *Set-up select* a selection is made to define how Bit 13/14 gates with the corresponding function on the digital inputs.

Bit 15 Reverse:

Bit 15 = '0' causes no reversing.

Bit 15 = '1' causes reversing.

Note: In the factory setting reversing is set to *digital* in par. 8-54 *Reversing select*.

Bit 15 causes reversing only when *Ser. communication, Logic AND* or *Logic OR* is selected.

Status Word according to FC Profile (STW)
(Par. 8-10 = FC profile)

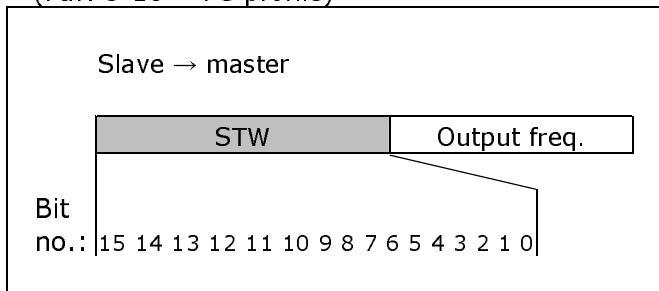

Bit	Bit = 0	Bit = 1
00	Control not ready	Control ready
01	Drive not ready	Drive ready
02	Coasting	Enable
03	No error	Trip
04	No error	Error (no trip)
05	Reserved	-
06	No error	Trip lock
07	No warning	Warning
08	Speed ≠ reference	Speed = reference
09	Local operation	Bus control
10	Out of frequency limit	Frequency limit ok
11	No operation	In operation
12	Drive ok	Stopped, auto start
13	Voltage ok	Voltage exceeded
14	Torque ok	Torque exceeded
15	Thermal ok	Thermal exceeded

Explanation of the Status Bits

Bit 00, Control ready:

Bit 00 = '0' means that the frequency converter has tripped.
 Bit 00 = '1' means that the frequency converter controls are ready, but that the power component is not necessarily receiving any power supply (in the event of external 24 V supply to controls).

Bit 01, Drive ready:

Bit 01 = '1'. The frequency converter is ready for operation.

Bit 02, Coasting stop:

Bit 02 = '0'. The frequency converter has released the motor.
 Bit 02 = '1'. The frequency converter can start the motor when a start command is given.

Bit 03, No error/Trip:

Bit 03 = '0' means that the frequency converter is not in fault mode.
 Bit 03 = '1' means that the frequency converter is tripped, and that a reset signal is required to re-establish operation.

Bit 04, No error/Error (no trip):

Bit 04 = '0' means that the frequency converter is not in fault mode.
 Bit 04 = '1' means that there is a frequency converter error but no trip.

Bit 05, Reserved:

Bit 05 is not used in the status word.

Bit 06, No error / Trip lock:

Bit 06 = '0' means that the frequency converter is not in fault mode.
 Bit 06 = '1' means that the frequency converter is tripped, and locked.

Bit 07, No warning/Warning:

Bit 07 = '0' means that there are no warnings.
 Bit 07 = '1' means that a warning has occurred.

Bit 08, Speed≠ reference/Speed = reference:

Bit 08 = '0' means that the motor is running, but that the present speed is different from the preset speed reference. For example, this might occur while the speed is being ramped up/down during start/stop.
 Bit 08 = '1' means that the present motor speed matches the preset speed reference.

Bit 09, Local operation/Bus control:

Bit 09 = '0' means that [STOP/RESET] is activated on the control unit, or that *Local control* in par. 3-13 *Reference site* is selected. It is not possible to control the frequency converter via serial communication.
 Bit 09 = '1' means that it is possible to control the frequency converter via the fieldbus/ serial communication.

Bit 10, Out of frequency limit:

Bit 10 = '0', if the output frequency has reached the value in par. 4-11 *Motor speed low limit* or par. 4-13 *Motor speed high limit*.
 Bit 10 = '1' means that the output frequency is within the defined limits.

Bit 11, No operation/In operation:

Bit 11 = '0' means that the motor is not running.
 Bit 11 = '1' means that the frequency converter has a start signal or that the output frequency is greater than 0 Hz.

Bit 12, Drive OK/Stopped, auto start:

Bit 12 = '0' means that there is no temporary over temperature on the inverter.

Bit 12 = '1' means that the inverter has stopped because of over temperature, but that the unit has not tripped and will resume operation once the over temperature stops.

Bit 13, Voltage OK/Voltage exceeded:

Bit 13 = '0' means that there are no voltage warnings.

Bit 13 = '1' means that the DC voltage in the frequency converter's intermediate circuit is too low or too high.

Bit 14, Torque OK/Torque limit exceeded:

Bit 14 = '0' means that the motor current is lower than the torque limit selected in par. 4-16 and 4-17 *Torque limit*.

Bit 14 = '1' means that the torque limit in par. 4-16 and 4-17 *Torque limit* has been exceeded. The nominal torque can be read in par. 16-16 *Torque*.

Bit 15, Thermal OK/limit exceeded:

Bit 15 = '0' means that the timers for both motor thermal protection and VLT thermal protection, have not exceeded 100%.

Bit 15 = '1' means that one of the limits has exceeded 100%.

ODVA Control Profile

Control Word under Instances 20/70 and 21/71

Set par. 8-10 *Control Word Profile* to ODVA.

The control word in Instances 20 and 21 is defined as follows:

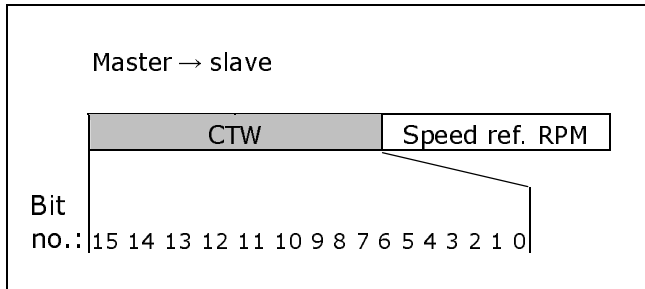

N.B.: Note that the bits 00 and 02 in Instance 20 are identical with bits 00 and 02 in the more extensive Instance 21.

Bit	Instance 20		Instance 21	
	Bit = 0	Bit = 1	Bit = 0	Bit = 1
00	Stop	Run Fwd	Stop	Run Fwd
01	-	-	Stop	Run Rev
02	No function	Fault reset	No function	Fault reset
03	-	-	-	-
04	-	-	-	-
05	-	-	-	Net Ctrl
06	-	-	-	Net Ref
07-15	-	-	-	-

Explanation of the Bits:

Bit 0, Run Fwd:

Bit 0 = "0" means that the VLT frequency converter has a stop command.

Bit 0 = "1" leads to a start command and the VLT frequency converter will start to run the motor clockwise.

Bit 1, Run Rev:

Bit 1 = "0" leads to a stop of the motor.

Bit 1 = "1" leads to a start of the motor.

Bit 2, Fault Reset:

Bit 2 = "0" means that there is no trip reset.

Bit 2 = "1" means that a trip is reset.

Bit 3, No function:

Bit 3 has no function.

Bit 4, No function:

Bit 4 has no function.

Bit 5, Net Control:

Bit 5 = "0" means that the drive is controlled from the standard inputs.

Bit 5 = "1" means that EIP controls the drive.



N.B.:

Please note that changes will affect parameters 8-50 to 8-56.

Bit 6, Net Reference:

Bit 6 = "0" Reference is from the standard inputs.

Bit 6 = "1" Reference is from EIP.



N.B.:

Please note that changes will affect parameters 3-15 to 3-17 *Reference source X*.

For the Speed reference, see section *Bus speed reference value under Instances 20/70 and 21/71*.

Status Word under Instances 20/70 and 21/71

The status word in Instances 70 and 71 is defined as follows:

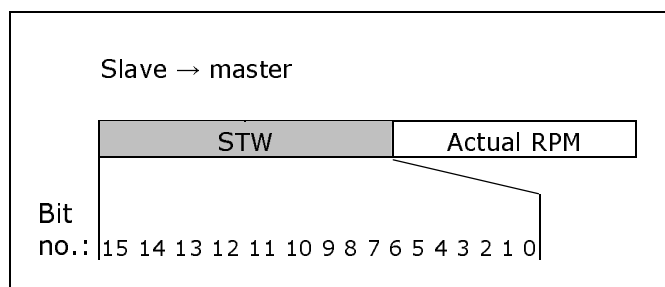

Note that the bits 00 and 02 in Instance 70 are identical with bits 00 and 02 in the more extensive Instance 71.

Bit	Instance 70		Instance 71	
	Bit = 0	Bit = 1	Bit = 0	Bit = 1
00	No Fault	Fault	No Fault	Fault
01	-	-	-	Warning
02	-	Running 1 Fwd	-	Running 1 Fwd
03	-	-	-	Running 2 Rev.
04	-	-	-	Ready
05	-	-	-	Ctrl from Net
06	-	-	-	Ref. from Net
07	-	-	-	At ref.
08-15	-	-	State Attribute	

Explanation of the Bits:

Bit 0, Fault:

Bit 0 = "0" means that there is no fault in the frequency converter.

Bit 0 = "1" means that there is a fault in the frequency converter.

Bit 1, Warning:

Bit 0 = "0" means that there is no unusual situation.

Bit 0 = "1" means that an abnormal condition has occurred.

Bit 2, Running 1:

Bit 2 = "0" means that the drive is not in one of these states or that Run 1 is not set.

Bit 2 = "1" means that the drive state attribute is enabled or stopping, or that Fault-Stop and

bit 0 (Run 1) of the control word are set at the same time.

Bit 3, Running 2:

Bit 3 = "0" means that the drive is in neither of these states or that Run 2 is not set.

Bit 3 = "1" means that the drive state attribute is enabled or stopping, or that fault-stop and bit 0 (Run 2) of the control word are set at the same time.

Bit 4, Ready:

Bit 4 = "0" means that the state attribute is in another state.

Bit 4 = "1" means that the state attribute is ready, enabled or stopping.

Bit 5, Control from net:

Bit 5 = "0" means that the drive is controlled from the standard inputs.

Bit 5 = "1" means that EIP has control (start, stop, reverse) of the drive.

Bit 6, Ref from net:

Bit 6 = "0" means that the reference comes from inputs to the drive.

Bit 6 = "1" means that the reference comes from EIP.

Bit 7, At reference:

Bit 7 = "0" means that the motor is running, but that the present speed is different from the preset speed reference, i.e. the speed is being ramped up/down during start/stop.

Bit 7 = "1" means that the drive and reference speeds are equal.

Bit 8 - 15, State attribute:

(Instance 71 only)

Represents the state attribute of the drive, as indicated in the following table:

Bit Number	Meaning
8	(Vendor specific)
9	Start up
10	Not ready
11	Ready
12	Enabled
13	Stopping
14	Fault stop
15	Faulted

For more detail of the actual output speed, see the section *Actual output speed under Instances 20/70 and 21/71*.

Reference Handling

Bus Speed Reference Value under Instances 100-101-103/150-151-153

In FC-Profile (par. 8-10 = [0] FC profile) the reference is scaled as a normalized relative value in percent. The value is transmitted in hexadecimal:

0% = 0hex
 100% = 4000hex
 -100% = C000hex

Depending of the setting of par. 3-00 *Reference Range*, the reference is scaled from - Max. to + Max. or from Min. to Max.

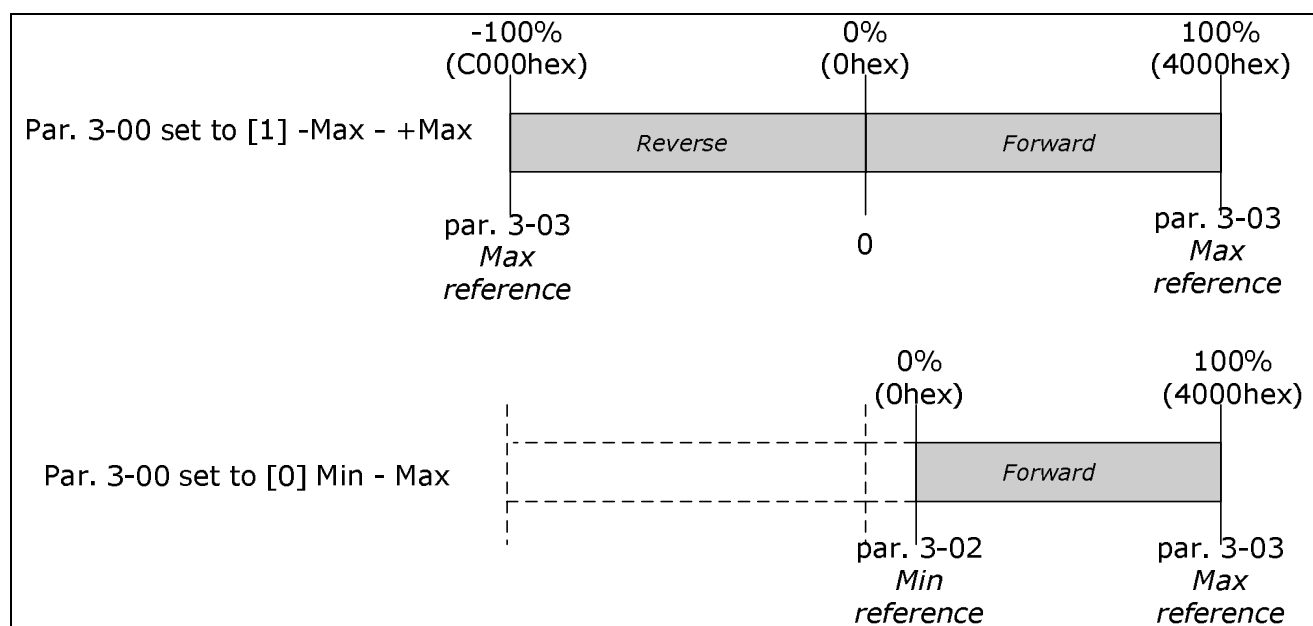

The actual reference [Ref. %] in the VLT depends on the settings in the following parameters:

- Parameter 1-23 *Motor frequency*
- Parameter 1-25 *Motor nominal speed*
- Parameter 3-02 *Minimum reference*
- Parameter 3-03 *Maximum reference*

All references provided to the frequency converter are added to the total reference value. If a reference is to be controlled by the fieldbus only, ensure that all other reference inputs are zero.

This means that digital and analogue input terminals should not be used for reference signals. The default setting (0%) should be maintained for preset references in par. 3-10 *Preset Reference*.

Note that if the bus speed reference is negative, and the control word contains a run reverse signal, the drive will run clockwise (- is +).

MAV is scaled in the same way as the reference.

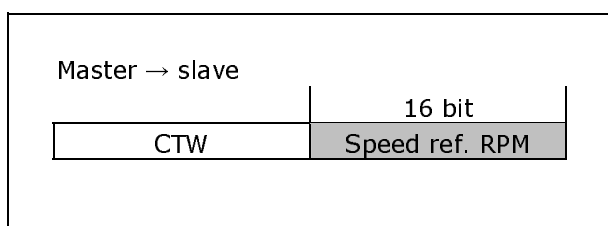
Bus Speed Reference Value under Instances 20/70 and 21/71

The speed reference value should be transmitted to the VLT frequency converter in the form of a 16-bit word. The value is transmitted directly in RPM.

Parameters

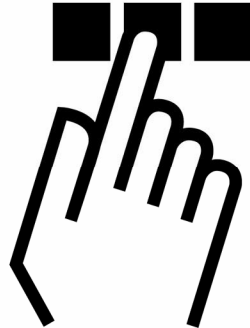

(8-01) Control Site

Option:

*Digital and control word	[0]
Digital only	[1]
Control word only	[2]

Function:

Select *Digital and ctrl. word* [0] for control using both digital input and control word.
 Select *Digital only* [1] for control using digital inputs only.
 Select *Control word only* [2] for control using control word only.
 The setting in this parameter overrules the settings in par. 8-50 to 8-56.

(8-02) Control Word Source

Option:

None	[0]
FC RS485	[1]
FC USB	[2]
*Option A	[3]
Option B	[4]
Option C0	[5]
Option C1	[6]

Function:

Select the source of the control word: one of two serial interfaces or four installed options. This parameter must be set to [3] *Option A* to enable control from the EtherNet/IP option. This parameter cannot be adjusted while the motor is running.

(8-03) Control Word Timeout Time

Range:

0.1 - 18000.0 s
 * 1.0 s

Function:

Enter the maximum time expected to pass between the reception of two consecutive telegrams (containing a CTW). If this time is exceeded, it indicates that the serial communication has stopped. The function selected in par. 8-04 *Control Word Time-out Function* will then be carried out.

(8-04) Control Word Timeout Function

Option:

*Off	[0]
Freeze Output	[1]
Stop	[2]
Jogging	[3]
Max. Speed	[4]
Stop and trip	[5]
Select set-up 1	[7]
Select set-up 2	[8]
Select set-up 3	[9]
Select set-up 4	[10]

Function:

Select the time-out function. The time-out function activates if the following CTW fails to be updated within the time period specified in par. 8-03 *Control Word Time-out Time*.

- *Off* [0]: Resume control via serial bus (Fieldbus or standard) using the most recent control word.

- *Freeze output* [1]: Freeze output frequency until communication resumes.
- *Stop* [2]: Stop with auto restart when communication resumes.
- *Jogging* [3]: Run the motor at JOG frequency until communication resumes.
- *Max. freq.* [4]: Run the motor at maximum frequency until communication resumes.
- *Stop and trip*[5]: Stop the motor, then reset the frequency converter in order to restart: via the fieldbus, via the reset button on the LCP or via a digital input.
- *Select set-up 1-4* [7] - [10]: This option changes the set-up upon reestablishment of communication following a control word time-out. If communication resumes causing the time-out situation to disappear, par. 8-05 *End-of-time-out Function* defines whether to resume the set-up used before the time-out or to retain the set-up endorsed by the time-out function. Note the following configuration required in order to change the set-up after a time-out: Set Par. 0-10 *Active set-up to Multi set-up* [9], and select the relevant link in par. 0-12 *This Set-up Linked To*.

(8-05) End-of-timeout Function

Option:

*Hold set-up	[0]
Resume set-up	[1]

Function:

Select the action after receiving valid CTW following a time-out. This parameter is active only when par. 8-04 is set to *Set-up 1-4*.
Hold: The frequency converter retains the set-up selected in par. 8-04 and displays a warning, until par. 8-06 toggles. Then the frequency converter resumes its original set-up.
Resume: The frequency converter resumes the set-up active prior to the time-out.

(8-06) Reset Control Word Timeout

Option:

*Do not reset	[0]
Do reset	[1]

Function:

Select *Do reset* [1] to return the frequency converter to the original set-up following a control word time-out. When the value is set to *Do reset* [1], the frequency converter performs the reset and then immediately reverts to the *Do not reset* [0] setting.

Select *Do not reset* [0] to retain the set-up specified in par. 8-04 *Select setup 1-4* following a control word time-out.

This parameter is active only when *Hold set-up* [0] has been selected in par. 8-05 *End-of-Time-out Function*.

(8-07) Diagnosis Trigger

Option:

*Disable	[0]
Trigger on alarms	[1]
Trigger on alarms/warn.	[2]

Function:

This parameter has no function for EtherNet/IP.

(8-10) Control Word Profile

Option:

*FC profile	[0]
ODVA	[5]

Function:

Select the interpretation of the control and status words corresponding to the installed fieldbus. Only the selections valid for the fieldbus installed in slot A will be visible in the LCP display.

(8-13) Configurable Status Word

Option:

No function	[0]
* Profile Default	[1]
Alarm 68 Only	[2]
Trip excl Alarm 68	[3]
T18 DI status	[10]
T19 DI status	[11]
T27 DI status	[12]
T29 DI status	[13]
T32 DI status	[14]
T33 DI status	[15]
T37 DI status	[16]
Thermal warning	[21]
Brake fault (IGBT)	[30]
Out of ref range	[40]
Comparator 0	[60]
Comparator 1	[61]
Comparator 2	[62]
Comparator 3	[63]
Comparator 4	[64]
Comparator 5	[65]
Logic Rule 0	[70]
Logic Rule 1	[71]
Logic Rule 2	[72]
Logic Rule 3	[73]
Logic Rule 4	[74]

Logic Rule 5	[75]
SL digital out A	[80]
SL digital out B	[81]
SL digital out C	[82]
SL digital out D	[83]
SL digital out E	[84]
SL digital out F	[85]

Function:

Enables configuration of bit 12 to 15 in the Status Word. Profile Default corresponds to the profile default setting in par. 8-10 *Control Word Profile*.

(8-50) Coasting Select
Option:

Digital input	[0]
Bus	[1]
Logic AND	[2]
*Logic OR	[3]

Function:

Select control of the coasting function via the terminals (digital input) and/or via the fieldbus.

Select *Bus*[1], to activate the Start command via the serial communication port or fieldbus option.

Select *Logic AND*[2] to activate the Start command via the fieldbus/serial communication port, AND additionally via one of the digital inputs.

Select *Logic OR* [3] to activate the Start command via the fieldbus/serial communication port OR via one of the digital inputs.

 **N.B.** This parameter is active only when par. 8-01 *Control site* is set to [0] *Digital and control word*.

(8-51) Quick Stop Select
Option:

Digital input	[0]
Bus	[1]
Logic AND	[2]
*Logic OR	[3]

Function:

Select control of the Quick Stop function via the terminals (digital input) and/or via the fieldbus.

 **N.B.** This parameter is active only when par. 8-01 *Control site* is set to [0] *Digital and control word*.

(8-52) DC Brake Select
Option:

Digital input	[0]
Bus	[1]
Logic AND	[2]
*Logic OR	[3]

Function:

Select control of the DC brake via the terminals (digital input) and/or via the fieldbus.

 **N.B.** This parameter is active only when par. 8-01 *Control site* is set to [0] *Digital and control word*.

(8-53) Start Select
Option:

Digital input	[0]
Bus	[1]
Logic AND	[2]
*Logic OR	[3]

Function:

Select control of the frequency converter start function via the terminals (digital input) and/or via the fieldbus.

 **N.B.** This parameter is active only when par. 8-01 *Control site* is set to [0] *Digital and control word*.

(8-54) Reversing Select
Option:

Digital input	[0]
Bus	[1]
Logic AND	[2]
*Logic OR	[3]

Function:

Select control of the frequency converter reverse function via the terminals (digital input) and/or via the fieldbus.

 **N.B.** This parameter is active only when par. 8-01 *Control site* is set to [0] *Digital and control word*.

(8-55) Set-up Select

Option:

Digital input	[0]
Bus	[1]
Logic AND	[2]
*Logic OR	[3]

Function:

Select control of the frequency converter set-up selection via the terminals (digital input) and/or via the fieldbus.

 **N.B.** This parameter is active only when par. 8-01 *Control site* is set to [0] *Digital and control word*.

(8-56) Preset Reference Select

Option:

Digital input	[0]
Bus	[1]
Logic AND	[2]
*Logic OR	[3]

Function:

Select control of the frequency converter Preset Reference selection via the terminals (digital input) and/or via the fieldbus.

 **N.B.** This parameter is active only when par. 8-01 *Control site* is set to [0] *Digital and control word*.

(12-00) IP Address Assignment
Option:

*Manual	[0]
DHCP	[1]
BOOTP	[2]

Function:

Selects the IP Address assignment method.
If *Manual* is selected, the IP-address can be set in par. 12-01 *IP Address*.

(12-01) IP Address
Range:

*000.000.000.000 - 255.255.255.255

Function:

Configure the IP address of the option.
Read-only if par. 12-00 set to DHCP or BOOTP.

(12-02) Subnet Mask
Range:

*000.000.000.000 - 255.255.255.255

Function:

Configure the IP subnet mask of the option.
Read-only if par. 12-00 set to DHCP or BOOTP.

(12-03) Default Gateway
Range:

*000.000.000.000 - 255.255.255.255

Function:

Configure the IP default gateway of the option.
Read-only if par. 12-00 set to DHCP or BOOTP.

(12-04) DHCP Server
Option:

*000.000.000.000 - 255.255.255.255

Function:

Read only.
Displays the IP address of the found DHCP or BOOTP server.

(12-05) Lease Expires
Option:

dd:hh:mm:ss

Function:

Read only.
Displays the lease-time left for the current DHCP-assigned IP address.

(12-06) Name Servers
Option:

[0] Primary DNS	*000.000.000.000
[1] Secondary DNS	*000.000.000.000

Function:

IP addresses of Domain Name Servers.
Can be automatically assigned when using DHCP.

(12-07) Domain Name
Option:

(Max. 19 chars.)
*blank

Function:

Domain name of the attached network.
Can be automatically assigned when using DHCP.

(12-08) Host Name
Option:

(Max. 19 chars.)
*blank

Function:

Logical (given) name of option.

(12-09) Physical Address
Range:

00:1B:08:00:00:00 - 00:1B:08:FF:FF:FF

Function:

Read only
Displays the Physical (MAC) address of the option.

N.B.:

A power-cycle is necessary after setting the IP parameters manually.

(12-1*) Ethernet Link Parameters

[0] Port 1

[1] Port 2

- applies for whole parameter group.

(12-10) Link Status

Option:

*No link [0]

Link [1]

Function:

Read only.

Displays the link status of the Ethernet ports.

(12-11) Link Duration

Option:

Link Duration Port 1 (dd:hh:mm:ss)

Function:

Read only.

Displays the duration of the present link on each port in dd:hh:mm:ss.

(12-12) Auto Negotiation

Option:

Off [0]

*On [1]

Function:

Configures Auto Negotiation of Ethernet link parameters, for each port: ON or OFF.

If set to OFF, *Link Speed* and *Link Duplex* can be configured in par. 12-13 and 12-14.

(12-13) Link Speed

Option:

*None [0]

10 Mbps [1]

100 Mbps [2]

Function:

Forces the link speed for each port in 10 or 100 Mbps.

If par. 12-12 is set to: *ON*, this parameter is read only and displays the actual link speed.

"None" is displayed if no link is present.

(12-14) Link Duplex

Option:

Half Duplex [0]

*Full Duplex [1]

Function:

Forces the duplex for each port to Full or Half duplex.

If par. 12-12 is set to: *ON*, this parameter is read only.

(12-20) Control Instance

Option:

*None, 20, 21, 100, 101, 103

Function:

Read only.

Displays the originator-to-target connection point. If no CIP connection is present "None" is displayed.

(12-21) Process Data Config Write

Option:

[0 - 9] PCD write 0 - 9

Function:

Configuration of writeable process data.

(12-22) Process Data Config Read

Option:

[0 - 9] PCD read 0 - 9

Function:

Configuration of readable process data.

 **N.B.:** For configuration of 2-word (32-bit) parameter read/write, use 2 consecutive arrays in par. 12-21 and 12-22.

(12-28) Store Data Values

Option:

*Off	[0]
Store All set-up's	[1]

Function:

This parameter activates a function that stores all parameter values in the non-volatile memory (EEPROM) thus retaining parameter values at power-down.

- Off: The store function is inactive.
- Store All set-up's: All parameter value will be stored in the non-volatile memory, in all four setups.

The parameter returns to "Off".

(12-21) Store Always

Option:

*Off	[0]
On	[1]

Function:

Activates function that will always store received parameter data in non-volatile memory (EEPROM).

(12-30) Warning Parameter
Range:

0000 – FFFF hex

Function:

Read only.

Displays the EtherNet/IP specific 16-bit Status-word.

Bit	Description
0	Owned
1	Not used
2	Configured
3	Not used
4	Not used
5	Not used
6	Not used
7	Not used
8	Minor recoverable fault
9	Minor unrecoverable fault
10	Major recoverable fault
11	Major unrecoverable fault
12	Not used
13	Not used
14	Not used
15	Not used

(12-31) Net Reference
Option:

*Off	[0]
On	[1]

Function:

Read only.

Displays the reference source in Instance 21/71.

- Off: Reference from the network is not active.
- On: Reference from the network is active.

(12-32) Net Control
Option:

*Off	[0]
On	[1]

Function:

Read only.

Displays the control source in Instance 21/71.

- Off: Control via the network is not active..
- On: Control via the network is active

(12-33) CIP Revision
Range:

[0] Major version	(00 - 99)
[1] Minor version	(00 - 99)

Function:

Read only.

Displays the CIP-version of the option software.

(12-34) CIP Product Code
Range:

0 – 9999	
*1100	(FC 302)
*1110	(FC 301)

Function:

Read only.

Displays the CIP product code.

(12-37) COS Inhibit Timer
Range:

*0 – 65,535 ms

Function:

Read only

Change-Of-State inhibit timer.

If the option is configured for COS operation, this inhibit timer can be configured in the Forward Open telegram to prevent that continuously changing PCD data generates extensive network traffic.

The inhibit time is in milliseconds, 0 = disabled.

(12-38) COS Filters
Range:

[0 - 9] Filter 0 – 9 (0000 - FFFFhex)

Function:

Change-Of-State PCD filters.

Sets up a filter mask for each word of process data when operating in COS-mode.

Single bits in the PCD's can be filtered in/out.

(12-80) FTP Server
Range:

*Disable	[0]
Enable	[1]

Function:

Enables/disables the build-in FTP server.

(12-81) HTTP Server
Option:

*Disable	[0]
Enable	[1]

Function:

Enables/disables the build-in HTTP (web) server.

(12-82) SMTP service
Option:

*Disable	[0]
Enable	[1]

Function:

Enables/disables the SMTP (e-mail) service on the option.

(12-89) Transparent Socket Chanel Port
Range:

0 – 9999
*0

Function:

Configures the TCP port-number for the transparent socket channel.

This enables FC-telegrams to be sent transparently on Ethernet via TCP.

Default value is 0, 0 means disabled.

(12-90) Cable Diagnostics

Option:

*Disable	[0]
Enable	[1]

Function:

Enables/disables advanced Cable diagnosis function. If enabled, the distance to cable errors can be read out in par. 12-93. The parameter resumes to the default setting of *Disable* after the diagnostics have finished.

 **NB:** The cable diagnostics function will only be issued on ports where there is no link (see par. 12-10 *Link Status*)

(12-91) Auto Cross-Over

Option:

Disable	[0]
*Enable	[1]

Function:

Enables/disables the auto cross-over function.

 **NB:** Disabling of the auto cross-over function will require crossed Ethernet cables for daisy-chaining the options.

(12-92) IGMP Snooping

Option:

Disable	[0]
*Enable	[1]

Function:

Enables or disables the IGMP snooping function. This prevents flooding of the Ethernet protocol stack by only forwarding multicast packets to ports that are a member of the multicast group.

(12-93) Cable Error Length

Range:

[0] Error length Port 1	(0 – 200m)
[1] Error length Port 2	(0 – 200m)

Function:

If Cable Diagnostics is enabled in par. 12-90, the build-in switch is able via Time Domain Reflectometry (TDR). This is a measurement technique which detects common cabling problems such as open circuits, short circuits and impedance mismatches or breaks in transmission cables.

The distance from the option to the error is displayed in meters with an accuracy of +/- 2m.

The value 0 means no errors detected.

(12-94) Broadcast Storm Protection

Range:

[0] Protection Value Port 1	(*Off – 20%)
[1] Protection Value Port 2	(*Off – 20%)

Function:

The build-in switch is capable of protecting the switch system from receiving too many broadcast packages, which can use up network resources.

The value indicates a percentage of the total bandwidth that is allowed for broadcast messages.

Example:

The "OFF" means that the filter is disabled –all broadcast messages will be passed through.

The value "0%" means that no broadcast messages will be passed through.

A value of "10%" means that 10% of the total bandwidth is allowed for broadcast messages, if the amount of broadcast messages increases above the 10% threshold, they will be blocked.

(12-95) Broadcast Storm Filter

Option:

Broadcast only	[0]
Broadcast & Multicast	[1]

Function:

Applies to par. 12-94; if the Broadcast Storm Protection should also include Multicast telegrams.

(12-98) Interface Counters

Range:

In Octets	[0]
In Unicast Packets	[1]
In Non-Unicast Packets	[2]
In Discards	[3]
In Errors	[4]
In Unknown Protocols	[5]
Out Octets	[6]
Out Unicast Packets	[7]
Out Non-Unicast Packets	[8]
Out Discards	[9]
Out Errors	[10]

Function:

Read only.

Advanced Interface counters, from build-in switch, can be used for low-level troubleshooting,

The parameter shows a sum of port 1 + port 2.

(12-99) Media Counters

Range:

Alignment Errors	[0]
FCS Errors	[1]
Single Collisions	[2]
Multiple Collisions	[3]
SQE Test Errors	[4]
Deferred Errors	[5]
Late Collisions	[6]
Excessive Collisions	[7]
MAC Transmit Errors	[8]
Carrier Sense Errors	[9]
Frame Too Long	[10]
MAC Receive Errors	[11]

Function:

Read only.

Advanced Interface counters, from build-in switch, can be used for low-level troubleshooting,

The parameter shows a sum of port 1 + port 2.

Parameter List

PNU	Parameter Name	Default value	Range	Conv. Index	Data Type	Array
8-0x	Communication and options					
8-01	Control Site	Dig. and ctrl. word [0]	[0 - 2]	-	Unsigned 8	-
8-02	Control Word Source	Option A [3]	[0 - 4]	-	Unsigned 8	-
8-03	Control Word Timeout Time	1.0 s	0.1 - 18000	-1	Unsigned 32	-
8-04	Control Word Timeout Function	Off [0]	[0 - 10]	-	Unsigned 8	-
8-05	End-of-timeout Function	Hold set-up [0]	[0 - 1]	-	Unsigned 8	-
8-06	Reset Control Word Timeout	Do not reset [0]	[0 - 1]	-	Unsigned 8	-
8-07	Diagnosis Trigger	Disable [0]	[0 - 3]	-	Unsigned 8	-
8-10	Control Word Profile	FC profile [0]	[0 - 5]	-	Unsigned 8	-
8-13	Configurable Status Word	Profile default [1]	[0 - 85]	-	Unsigned 8	[12-15]
8-5x	Digital/Bus					
8-50	Coasting Select	Logic OR [3]	[0 - 3]	-	Unsigned 8	-
8-51	Quick Stop Select	Logic OR [3]	[0 - 3]	-	Unsigned 8	-
8-52	DC Brake Select	Logic OR [3]	[0 - 3]	-	Unsigned 8	-
8-53	Start Select	Logic OR [3]	[0 - 3]	-	Unsigned 8	-
8-54	Reversing Select	Logic OR [3]	[0 - 3]	-	Unsigned 8	-
8-55	Set-up Select	Logic OR [3]	[0 - 3]	-	Unsigned 8	-
8-56	Preset Reference Select	Logic OR [3]	[0 - 3]	-	Unsigned 8	-
12-0x	IP settings					
12-00	IP Address Assignment	0.0.0.0	0 - 255	-	Unsigned 8	-
12-01	IP Address	0.0.0.0	0 - 255	-	Oct. string 4	-
12-02	Subnet Mask	0.0.0.0	0 - 255	-	Oct. string 4	-
12-03	Default Gateway	0.0.0.0	0 - 255	-	Oct. string 4	-
12-04	DHCP Server	0.0.0.0	0 - 255	-	Oct. string 4	-
12-05	Lease Expires	00:00:00:00	-	-	Time diff. w/date	-
12-06	Name Servers	0.0.0.0	0 - 255	-	Oct. string 4	-
12-07	Domain Name	-	max. 19 ch.	-	Visible string 48	-
12-08	Host Name	-	max. 19 ch.	-	Visible string 48	-
12-09	Physical Address	00:1B:08:00:00:00	-	-	Visible string 17	-
12-1x	Ethernet Link Parameters					
12-10	Link Status	No Link [0]	[0 - 1]	-	Unsigned 8	[0-1]
12-11	Link Duration	00:00:00:00	-	-	Time diff. w/date	[0-1]
12-12	Auto Negotiation	On [1]	[0 - 1]	-	Unsigned 8	[0-1]
12-13	Link Speed	None [0]	[0 - 2]	-	Unsigned 8	[0-1]
12-14	Link Duplex	Full Duplex [1]	[0 - 1]	-	Unsigned 8	[0-1]
12-2x	Process Data					
12-20	Control Instance	None	20 - 103	-	Unsigned 8	-
12-21	Process Data Config Write	-	-	-	Unsigned 16	[0-9]
12-22	Process Data Config Read	-	-	-	Unsigned 16	[0-9]
12-28	Store Data Values	Off [0]	[0 - 1]	-	Unsigned 8	-
12-29	Store Always	Off [0]	[0 - 1]	-	Unsigned 8	-
12-3x	EtherNet/IP					
12-30	Warning Parameter	0000 hex	0000-FFFF	-	Unsigned 16	-
12-31	Net Control	Off [0]	[0 - 1]	-	Unsigned 8	-
12-32	Net Reference	Off [0]	[0 - 1]	-	Unsigned 8	-
12-33	CIP Revision	00	0 - 99	-	Unsigned 16	[0-1]
12-34	CIP Product Code	0	9999	-	Unsigned 16	[0-1]
12-37	COS Inhibit Timer	0	0 - 65535	0	Unsigned 16	-
12-38	COS Filters	0000	0000-FFFF	-	Unsigned 16	[0-9]
12-8x	Other Ethernet Services					
12-80	FTP Server	Disable [0]	[0 - 1]	-	Unsigned 8	-
12-81	HTTP Server	Disable [0]	[0 - 1]	-	Unsigned 8	-
12-82	SMTP Service	Disable [0]	[0 - 1]	-	Unsigned 8	-
12-89	Transp. Socket Channel Port	Disable [0]	[0 - 1]	-	Unsigned 8	-
12-9x	Advanced Ethernet Settings					
12-90	Cable Diagnostics	Disable [0]	[0 - 1]	-	Unsigned 8	-
12-91	Auto Cross-Over	Enable [0]	[0 - 1]	-	Unsigned 8	-
12-92	IGMP Snooping	Enable [0]	[0 - 1]	-	Unsigned 8	-
12-93	Cable Error Length	0	0 - 200	0	Unsigned 16	[0-1]
12-94	Broadcast Storm Protection	0	Off - 20%	-	Unsigned 16	[0-1]
12-95	Broadcast Storm Filter	Enable [1]	[0 - 1]	-	Unsigned 8	[0-1]
12-98	Interface Counters	0	0 - 65535	-	Unsigned 16	[0-10]
12-99	Media Counters	0	0 - 65535	-	Unsigned 16	[0-11]

Data Types Supported by FC 100/200/300

Conversion index

This number to the left refers to a conversion figure on the right to be used when writing or reading parameters.

Conversion index	Conversion factor
67	1/60
6	1000000
5	100000
4	10000
3	1000
2	100
1	10
0	1
-1	0.1
-2	0.01
-3	0.001
-4	0.0001
-5	0.00001
-6	0.000001

Troubleshooting

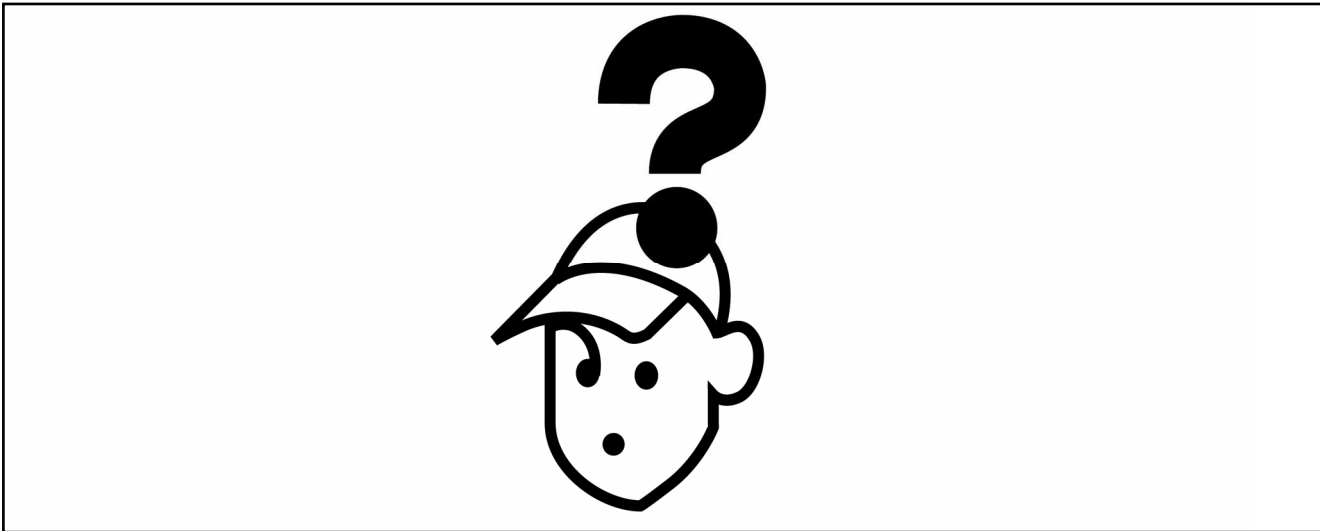

Step-by-step troubleshooting

Check: LED's

The option contains two LED's to indicate the state of the device and the network. During normal operation the MS and at least one NS LED will show a constant green light.

State	LED		Description
MS: Module Status			
Standby	Green:	Flashing green	The device needs commissioning
Device operational	Green:	Solid green	The device is operational
Major recoverable fault	Red:	Flashing red	The device has detected a recoverable fault (MAR)
Major unrecoverable fault	Red:	Steady red	The device has detected a un-recoverable fault (MAU)
Self test	Red: Green:	Flashing red/green	The EIP option is in self-test mode.
NS1 + NS2: Network status (one per port)			
No connections	Green:	Flashing green	There are no established any CIP connections to the device
Connected	Green:	Steady green	There is established (at least) one CIP connection to the device
Connection time-out	Red:	Flashing red	One or more CIP connections has timed-out
Duplicate IP	Red:	Steady red	The IP-address assigned to the device is already in use
Self test	Red: Green:	Flashing red/green	The EIP option is in self-test mode.

Check: Link status

The status of the Ethernet link cannot be directly identified by means of the LED's, if no CIP connection is established.

Use par. 12-10 *Link Status* to verify presents of the link.

Use par. 12-11 *Link Duration* to verify that the link is steady present. The parameter will show the duration of the present link, and preset to 00:00:00:00 if the link is broken.

Check: Cabling

In rare cases of cabling mis-configuration, the option might show the presents of a link, but no communication is running. Exchange the cable in doubt.

Check: IP address

Verify that the option has a valid IP address (please refer to section: *IP Settings*) in par. 12-01 *IP Address*. If the option has identified a duplicate IP Address NS LED's will light steady red.

If the option is set up for BOOTP or DHCP, verify that a BOOTP or DHCP server is connected in par. 12-04 *DHCP Server*. If no server is connected, the parameter will show: 000.000.000.000.

Alarm Word and Warning Word

Alarm word and warning word are shown in the display in Hex format. If there is more than one warning or alarm, a sum of all warnings or alarms will be shown. Warning word and alarm word are displayed in par. 16-90 to 16-95.

For more information on the individual alarms and warnings, please refer to: *FC 100/200/300 Design Guide*



N.B.

Please note that the availability of the individual alarms and warnings are dependent on the drive type: FC100/200/300 series.

Warning and Alarm Messages

There is a clear distinction between alarms and warnings. In the event of an alarm, the frequency converter will enter a fault condition. After the cause for the alarm has been cleared, the master must acknowledge the alarm message in order to start operation of the frequency converter again. A warning, on the other hand, may appear when a warning condition arises, then disappear when conditions return to normal without interfering with the process.

Warnings

All warnings within the frequency converter are represented by a single bit within a warning word. A warning word is always an action parameter. Bit status FALSE [0] means no warning, while bit status TRUE [1] means warning. Each bit status has a corresponding text string message. In addition to the warning word message the master will also be notified via a change in the status word.

Alarms

Following an alarm message the frequency converter will enter a fault condition. Only after the fault has been rectified and the master has acknowledged the alarm message by a bit in the Control Word, can the VLT resume operation. All alarms within the VLT are represented by a single bit within an alarm word. An alarm word is always an action parameter. Bit status FALSE [0] means no alarm, while bit status TRUE [1] means alarm.

In CIP, Alarms are divided in to two categories:

- Major Recoverable Faults
- Major Unrecoverable Faults

Please refer to the following sections for a classification of the specific faults.

Bit (Hex)	Alarm word (Par. 16-90)	CIP Classification
00000001	Brake check	-
00000002	Power card over temperature	MAR
00000004	Earth fault	MAU
00000008	Ctrl. card over temperature	-
00000010	Control word timeout	MAR
00000020	Over current	MAU
00000040	Torque limit	MAR
00000080	Motor thermistor over temp.	MAR
00000100	Motor ETR over temperature	MAR
00000200	Inverter overloaded	MAR
00000400	DC link under voltage	MAR
00000800	DC link over voltage	MAR
00001000	Short circuit	MAU
00002000	Inrush fault	MAR
00004000	Mains phase loss	MAU
00008000	AMA not OK	MAR
00010000	Live zero error	MAR
00020000	Internal fault	MAU
00040000	Brake overload	MAU
00080000	Motor phase U is missing	MAU
00100000	Motor phase V is missing	MAU
00200000	Motor phase W is missing	MAU
00400000	Fieldbus fault	MAR
00800000	24V supply fault	MAU
01000000	Mains failure	MAR
02000000	1.8V supply fault	MAU
04000000	Brake resistor short circuit	MAR
08000000	Brake chopper fault	MAR
10000000	Option change	-
20000000	Drive initialized	-
40000000	Safe Stop	MAR
80000000	Mech. Brake low	-

MAR = Major Recoverable Fault

MAU = Major Unrecoverable Fault

Bit (Hex)	Alarm word 2 (Par 16-91)	Bit (Hex)	Warning word (Par 16-92)
00000001	Service Trip, Read/Write	00000001	Brake check
00000002	Reserved	00000002	Power card over temperature
00000004	Service Trip, Typecode/Sparepart	00000004	Earth fault
00000008	Reserved	00000008	Control card over temperature
00000010	Reserved	00000010	Control word timeout
00000020	No Flow	00000020	Over current
00000040	Dry Pump	00000040	Torque limit
00000080	End of Curve	00000080	Motor thermistor over temp.
00000100	Broken Belt	00000100	Motor ERT over temperature
00000200	Discharge high	00000200	Inverter overloaded
00000400	Start failed	00000400	DC link under voltage
00000800	Speed limit	00000800	DC link over voltage
00001000	Reserved	00001000	DC link voltage low
00002000	Reserved	00002000	DC link voltage high
00004000	Reserved	00004000	Mains phase loss
00008000	Reserved	00008000	No motor
00010000	Reserved	00010000	Live zero error
00020000	KTY error	00020000	10V low
00040000	Fans error	00040000	Brake resistor power limit
00080000	ECB error	00080000	Brake resistor short circuit
00100000	Reserved	00100000	Brake chopper fault
00200000	Reserved	00200000	Speed limit
00400000	Reserved	00400000	Fieldbus comm. fault
00800000	Reserved	00800000	24V supply fault
01000000	Reserved	01000000	Mains failure
02000000	Reserved	02000000	Current limit
04000000	Reserved	04000000	Low temperature
08000000	Reserved	08000000	Voltage limit
10000000	Reserved	10000000	Encoder loss
20000000	Reserved	20000000	Output frequency limit
40000000	PTC thermistor	40000000	Safe stop
80000000	Dangerous failure	80000000	Extended status word

Bit (Hex)	Warning word 2 (Par 16-93)
00000001	Start Delayed
00000002	Stop Delayed
00000004	Clock Failure
00000008	Firemode was active
00000010	Reserved
00000020	No Flow
00000040	Dry Pump
00000080	End of Curve
00000100	Broken Belt
00000200	Discharge high
00000400	Reserved
00000800	Reserved
00001000	Reserved
00002000	Reserved
00004000	Reserved
00008000	Reserved
00010000	Reserved
00020000	KTY warning
00040000	Fans warning
00080000	ECB warning
00100000	Reserved
00200000	Reserved
00400000	Reserved
00800000	Reserved
01000000	Reserved
02000000	Reserved
04000000	Reserved
08000000	Reserved
10000000	Reserved
20000000	Reserved
40000000	PTC thermistor
80000000	Reserved

Bit (Hex)	Extended status word (Par 16-94) FC 100 only !!
00000001	Ramping
00000002	AMA Running
00000004	Start CW/CCW
00000008	Slow Down
00000010	Catch Up
00000020	Feedback high
00000040	Feedback low
00000080	Output current high
00000100	Output current low
00000200	Output frequency high
00000400	Output frequency low
00000800	Brake check OK
00001000	Braking max
00002000	Braking
00004000	Out of speed range
00008000	OVC active
00010000	AC brake
00020000	Password Timelock
00040000	Password Protection
00080000	Reference high
00100000	Reference low
00200000	Local Ref./Remote Ref.
00400000	Reserved
00800000	Reserved
01000000	Reserved
02000000	Reserved
04000000	Reserved
08000000	Reserved
10000000	Reserved
20000000	Reserved
40000000	Reserved
80000000	Reserved

- Troubleshooting -

Bit (Hex)	Extended status word 2 (Par 16-95) FC 100 only !!
00000001	Off
00000002	Hand/Auto
00000004	PROFibus OFF1 active
00000008	PROFibus OFF2 active
00000010	PROFibus OFF3 active
00000020	Relay 123 active
00000040	Start Prevented
00000080	Control ready
00000100	Drive ready
00000200	Quick Stop
00000400	DC Brake
00000800	Stop
00001000	Stand By
00002000	Freeze Output Request
00004000	Freeze Output
00008000	Jog Request
00010000	Jog
00020000	Start Request
00040000	Start
00080000	Start Applied
00100000	Start Delay
00200000	Sleep
00400000	Sleep Boost
00800000	Running
01000000	Bypass
02000000	Fire Mode
04000000	Reserved
08000000	Reserved
10000000	Reserved
20000000	Reserved
40000000	Reserved
80000000	Reserved

Appendix

Supported CIP Objects

As in all implementations of CIP, EtherNet/IP shares the common Object Model. Objects are a common method to describe the specific application implemented in a device.

Data is structured in Classes, Instances and Attributes:

A **class** is a group of objects with the same structure. These groups of objects within a class are called **instances**. Every instance provides the same data elements called **attributes**. Each class provides services to access data or to change the state of an object.

Class ID 0x01 Identity Object

Instance Attributes

Attribute	Access	Name	Data type	Description
1	Get	Vendor	UINT	(97) Danfoss Drives vendor code
2	Get	Device Type	UINT	(2) AC Drive
3	Get	Product Code	UINT	Value of par. 12-34
4	Get	Revision	Struct	Value of par. 12-33
5	Get	Status	WORD	EIP status word (par. 12-30)
6	Get	Serial Number	UDINT	Serial number
7	Get	Product Name	String	Value of par. 15-40 (e.g. "FC-302")
8	Get	State	UINT	0 = Non-existent 1 = Device Self Testing 2 = Standby 3 = Operational 4 = Major Recoverable Fault 5 = Major Unrecoverable Fault 6-254 = Reserved 255 = Default for Get Attribute All
9	Get	Conf. consistency value	UINT	

Class ID 0x04 Assembly Objects

Instance Attributes

Instance	Access	Name	Size	Description
20	Set	ODVA basic speed control Output	2 Words	
21	Set	ODVA extended speed control Output	2 Words	
70	Get	ODVA basic speed control Input	2 Words	
71	Get	ODVA extended speed control Input	2 Words	
100	Set	Danfoss Basic Control Output	2 Words	
101	Set	Danfoss Extended Control Output	4 Words	
103	Set	Danfoss Extended Control Output	10 Words	
150	Get	Danfoss Basic Control Input	2 Words	
151	Get	Danfoss Extended Control Input	4 Words	
153	Get	Danfoss Extended Control Input	10 Words	

Class ID 0x06 Connection Manager

Instance Attributes

Attribute	Access	Name	Data Type	Description
1	Get	Open Requests	UINT	Number of Forward Open requests received
2	Get	Open Format Rejects	UINT	Number of Forward Open requests rejected due to bad format
3	Get	Open Resource Rejects	UINT	Number of Forward Open requests rejected due to lack of resources
4	Get	Open Other Rejects	UINT	Number of Forward Open requests rejected due to other reasons
5	Get	Close Requests	UINT	Number of Forward Close requests received
6	Get	Close Format Requests	UINT	Number of Forward Close requests rejected due to bad format
7	Get	Close Other Requests	UINT	Number of Forward Close requests rejected due to other reasons
8	Get	Connection Timeouts	UINT	Number of connection timeouts
9	Get	Connection Entry List	Struct of:	
		NumConnEntries	INT	Number of connection entries
		ConnOpenBits	ARRAY of BOOL	List of connection data

Class ID 0x28 Motor Data Object

Instance Attributes

Attribute	Access	Name	Data Type	Parameter	Description
1	Get	Number of Attributes supported	USINT	-	7
2	Get	List of attributes supported	Array of USINT	-	3,6,7,8,9,12,15
3	Get/Set	Motor Type	USINT	1-10	3: PM sync. motor (FC 302 only) 7: Squirrel cage induction motor
6	Get/Set	Rated Current	UINT	1-24	Unit: 100 mA
7	Get/Set	Rated Voltage	UINT	1-22	Unit: Volt
8	Get/Set	Rated Power	UDINT	1-20	Unit: Watt
9	Get/Set	Rated Frequency	UINT	1-23	Unit: Hertz
12	Get/Set	Pole Count	UINT	1-39	Number of poles in motor
15	Get/Set	Base Speed	UINT	1-25	Unit: RPM



N.B. Class ID 0x28 is only available if ODVA profile is selected in par. 8-10.

Class ID 0x29 Control Supervisor Object

Instance Attributes

Attribute	Access	Name	Data Type	Description
1	Get	Number of Attributes supported	USINT	12
2	Get	List of supported Attributes	Array of USINT	3,4,4,5,6,7,8,9,10,11,12,13,15
3	Get/Set	Run 1 (forward)	Boolean	FC CTW Bit 6 = Run1 XOR Run2 FC CTW Bit15 = 0
4	Get/Set	Run 2 (reverse)	Boolean	FC CTW Bit 6 = Run1 XOR Run2 FC CTW Bit15 = 1
5	Get/Set	Network Control	Boolean	Parameter 12-32 value written from option
6	Get	State	USINT	The state of the CIP state-machine
7	Get	Running 1	Boolean	Run1 AND bit 11 in FC STW
8	Get	Running 2	Boolean	Run2 AND bit 11 in FC STW
9	Get	Ready	Boolean	STATE_ENABLED or STATE_STOPPING or STATE_FAULT_STOP from state-machine
10	Get	Faulted	Boolean	Bit 3 in FC STW
11	Get	Warning	Boolean	Bit 7 in FC STW
12	Get/Set	Fault reset	Boolean	Bit 7 in FC CTW
13	Get	Fault Code	UINT	Mapping of par. 16-90 Alarm Word to CIP specific fault codes
15	Get	Control from net	Boolean	Parameter 12-31 value written from option

Attribute 13 "Fault Code"

CIP Malfunction Code	Meaning	VLT-Code Alarmword	CIP Malfunction Meaning	CIP Classification
0	No alarm	0000 0000	No fault	-
0	unused	0000 0001	No fault	-
4210	Drive over temperature	0000 0002	Excessive Device Temperature	mar
2240	Earth fault	0000 0004	Short to earth	mau
0	unused	0000 0008	No fault	-
8100	Controlword timeout	0000 0010	Communication	mir
2310	Overcurrent	0000 0020	Continuous Overcurrent	mau
8302	Torque limit	0000 0040	Torque limiting	mar
4310	Motor thermistor	0000 0080	Excess Drive Temperature	mar
4310	Motor ETR over temp	0000 0100	Excess Drive Temperature	mar
2311	Inverter overloaded	0000 0200	Current inside the device, No. 1	mar
3220	DC Link undervoltage	0000 0400	Undervoltage inside the Device	mar
3210	DC Link overvoltage	0000 0800	Overvoltage inside the device	mar
2130	Short circuiting	0000 1000	Short Circuit	mau
2213	Inrush fault	0000 2000	Overcurr. during startup	mar
3130	Mains phase loss	0000 4000	Phase Failure	mau
5210	AMT fail	0000 8000	Measurement Circuit	mir
1000	Live zero fault	0001 0000	General fault	mar
6100	Internal fault	0002 0000	Internal software fault	mau
7110	Brake resistor power limit	0004 0000	Brake Chopper	mau
3300	Motor phase U missing	0008 0000	Output voltage	mau
3300	Motor phase V missing	0010 0000	Output voltage	mau
3300	Motor phase W missing	0020 0000	Output voltage	mau
8100	Fieldbus Comm. fault	0040 0000	Communication	mir
5112	24V supply fault	0080 0000	+24V Power supply	mau
3100	Mains failure	0100 0000	Mains Voltage	mar
5110	1,8V supply fault	0200 0000	Low voltage power supp.	mau
7110	Brake resist. short circ.	0400 0000	Brake chopper	mar
7110	Brake chopper fault	0800 0000	Brake chopper	mar

0	unused	1000 0000	No fault	-
0	unused	2000 0000	No fault	-
0	unused	4000 0000	No fault	-
0	unused	8000 0000	No fault	-

Mir = Minor Recoverable
 Mar = Major Recoverable
 Mau = Major Unrecoverable

Services supported:

Service Code	Service Name	Service Description
0Eh	Get_Attribute_Single	Returns contents of specified attribute
10h	Set_Attribute_Single	Sets the contents of specified attribute
05h	Reset	Resets drive to it's start-up state.



N.B. Class ID 0x29 is only available if ODVA profile is selected in par. 8-10.

Class ID 0x2A AC/DC Drive Object

Instance Attributes

Attribute	Access Rule	Information about	Data Type	Contents
1	Get	Number of Attributes Supported	USINT	12
2	Get	List of Attributes Supported	USINT	3,4,6,7,8,18,19,20,21,22,28,29
3	Get	At Reference	Boolean	Bit 8 of FC STW
4	Get/Set	Network Reference	Boolean	value written to parameter "Net Reference"
6	Get/Set	Drive Mode	USINT	Mapping of values from parameter 1-00
7	Get	Actual Speed	INT	See Attribute 22
8	Get/Set	Reference Speed	INT	See Attribute 22
18	Get/Set	Acceleration Time	UINT	Scaled with Attribute 28 and written to Parameter 341
19	Get/Set	Deceleration time	UINT	Scaled with Attribute 28 and written to Parameter 342
20	Get/Set	Low Speed Limit	UINT	Scaled with Attribute 22 and written to Parameter 411
21	Get/Set	High Speed Limit	UINT	Scaled with Attribute 22 and written to Parameter 413
22	Get/Set	Speed Scale	SINT	Forms the "Speed Reference" and "Main Actual Value" for the Drive together with Attribute 7 and 8
28	Get/Set	Time Scale	SINT	Scaling factor for all time attributes
29	Get	Ref From Net	Boolean	value of parameter "Net Reference"

Attribute 6 "Drive Mode"

Value of Attribute 6	ODVA Text	Value of par. 1-00	FC Text
0	Vendor specific	Remaining values not listed below	?
1	Open loop speed ctr.	0	Speed open loop
2	Closed loop speed ctr.	1	Speed closed loop
3	Torque Control	NA	NA
4	Process Control	NA	NA
5	Position Control	NA	NA



N.B. Class ID 0x2A is only available if ODVA profile is selected in par. 8-10.

Class ID 0xF5 Interface Object

Instance Attributes

Attribute	Access Rule	Name	Data Type	Description of Attribute	Parameter In Drive
1	Get	Status	DWORD	Interface status	-
2	Get	Configuration Capability	DWORD	Interface capability flags	-
3	Get/Set	Configuration Control	DWORD	Interface control flags	-
4	Get	Physical Link Object	STRUCT of:	Path to physical link object	-
		Path size	UINT	Size of Path	-
		Path	Padded EPATH	Logical segments identifying the physical link object	-
5	Get/Set	Interface Configuration	STRUCT of:	TCP/IP network interface configuration.	-
		IP Address	UDINT	The device's IP address.	12-01
		Network Mask	UDINT	The device's network mask.	12-02
		Gateway Address	UDINT	Default gateway address	12-03
		Name Server	UDINT	Primary name server	12-06 [0]
		Name Server 2	UDINT	Secondary name server	12-06 [0]
6	Get/Set	Domain Name	STRING	Default domain name	12-07
		Host Name	STRING	Host name	12-08

Class ID 0xF6 Link Object

Three instances of the Link Object are implemented:

- Instance 1 and 2 relates to the physical Port 1 and 2 of the option.
- Instance 3 relates to the internal interface of the option, after the build-in switch.

Instance Attributes

Attribute	Access Rule	Name	Data Type	Description of Attribute	Parameter in drive
1	Get	Interface Speed	UDINT	Interface speed in Mbps (e.g., 0, 10, 100, 1000, etc.)	12-13
2	Get	Interface Flags	DWORD	Interface status flags	-
3	Get	Physical Address	ARRAY of 6 USINTs	MAC layer address	12-09
4	Get	Interface Counters	STRUCT of		
		In Octets	UDINT	Octets received on the interface	12-98 [0]
		In Ucast Packets	UDINT	Unicast packets received on the interface	12-98 [1]
		In NUcast Packets	UDINT	Non-unicast packets received on the interface	12-98 [2]
		In Discards	UDINT	Inbound packets received on the interface but discarded	12-98 [3]
		In Errors	UDINT	Inbound packets that contain errors (does not include In Discards)	12-98 [4]
		In Unknown Protos	UDINT	Inbound packets with unknown protocol	12-98 [5]
		Out Octets	UDINT	Octets sent on the interface	12-98 [6]
		Out Ucast Packets	UDINT	Unicast packets sent on the interface	12-98 [7]
		Out NUcast Packets	UDINT	Non-unicast packets sent on the interface	12-98 [8]
		Out Discards	UDINT	Outbound packets discarded	12-98 [9]
Out Errors	UDINT	Outbound packets that contain errors	12-98 [10]		
5	Get	Media Counters	STRUCT of:	Media-specific counters	
		Alignment Errors	UDINT	Frames received that are not an integral number of octets in length	12-99 [0]
		FCS Errors	UDINT	Frames received that do not pass the FCS check	12-99 [1]

		Single Collisions	UDINT	Successfully transmitted frames which experienced exactly one collision	12-99 [2]
		Multiple Collisions	UDINT	Successfully transmitted frames which experienced more than one collision	12-99 [3]
		SQE Test Errors	UDINT	Number of times SQE test error message is generated	12-99 [4]
		Deferred Transmissions	UDINT	Frames for which first transmission attempt is delayed because the medium is busy	12-99 [5]
		Late Collisions	UDINT	Number of times a collision is detected later than 512 bit times into the transmission of a packet	12-99 [6]
		Excessive Collisions	UDINT	Frames for which transmission fails due to excessive collisions	12-99 [7]
		MAC Transmit Errors	UDINT	Frames for which transmission fails due to an internal MAC sub layer transmit error	12-99 [8]
		Carrier Sense Errors	UDINT	Times that the carrier sense condition was lost or never asserted when attempting to transmit a frame	12-99 [9]
		Frame Too Long	UDINT	Frames received that exceed the maximum permitted frame size	12-99 [10]
		MAC Receive Errors	UDINT	Frames for which reception on an interface fails due to an internal MAC sub layer receive error	12-99 [11]
6	Set	Interface Control	STRUCT of:	Configuration for physical interface	-
		Control Bits	WORD	Interface Control Bits	-
		Forced Interface Speed	UINT	Speed at which the interface shall be forced to operate Speed in Mbps (10, 100, 1000, etc.)	-
7	Get	Interface Label	SHORT_STRING	Human readable identification	-
8	Get	Link List Size	USINT	Number of members in Link List	-
9	Get	Link List	ARRAY OF UINT	Link List between internal and all according external interfaces	-

Services supported:

Service Code	Supported		Service Name	Description of Service
	Class	Instance		
01h	Yes	Yes	Get_Attribute_All	Returns a predefined listing of this objects attributes
0Eh	Yes	Yes	Get_Attribute_Single	Returns the contents of the specified attribute.
10h	-	Yes	Set_Attribute_Single	Modifies a single attribute.
43h	-	Yes	Get_and_Clear	Gets then clears the specified attribute (Interface Counters or Media Counters).

Class ID 0x0F Parameter Object

Class attributes

Attribute	Access Rule	Name	Data Type	Description of Attribute	Contents
1	Get	Revision	UINT	revision of object	01
2	Get	Max Instance	UINT	max instance number	variable
3	Get	Number of instances	UINT	amount of instances	variable
8	Get	Parameter Class Descriptor	WORD	Parameter description	0x03
9	Get	Configuration Assembly Instance	UINT	instance number of the configuration assembly	0
10	Get/Set	Native Language	USINT	Language ID for all character array accesses	variable

Instance attributes

Attribute	Access Rule	Name	Data type	Description	Value
1	Set/Get	Parameter Value	<i>data type described in Attr. 5</i>	actual value of parameter	Value of parameter from drive
2	Get	Link path size	USINT	Size of link path	variable
3	Get	Link path	ARRAY:	CIP path of parameter's origin	variable
		Segment type/port	BYTE		
		Segment Address	path		
4	Get	Descriptor	WORD	Description of parameter	See Standard
5	Get	Data Type	EPATH	Data type code	-
6	Get	Data size	USINT	Number of bytes in parameter value	variable
7	Get	Parameter name string	SHORT STRING	human readable text string representing parameter name	Parameter Attribute From drive
8	Get	Units string	SHORT STRING	human readable text string representing parameter unit	Parameter Attribute From drive
9	Get	Help String	SHORT STRING	human readable text string representing short online help.	Parameter Attribute From drive
10	Get	min value	<i>data type described in Attr. 5</i>	Generic min valid value	Parameter Attribute From drive
11	Get	max value	<i>data type described in Attr. 5</i>	Generic max valid value	Parameter Attribute From drive
12	Get	default value	<i>data type described in Attr. 5</i>	Generic parameter's default value	Parameter Attribute From drive
13	Get	Scaling multiplier	UINT	multiplier for scaling factor	1
14	Get	Scaling divisor	UINT	divisor for scaling factor	1
15	Get	Scaling base	UINT	base for scaling formula	0
16	Get	Scaling offset	INT	offset for scaling formula	0
17	Get	Multiplier link	UINT	parameter instance of multiplier source	0
18	Get	divisor link	UINT	parameter instance of divisor source	0
19	Get	base link	UINT	parameter instance of base source	0
20	Get	offset link	UINT	parameter instance of offset source	0
21	Get	decimal precision	USINT	specifies parameter value format	variable

Services supported

Service Code	Implemented		Service Name	Service Description
	Class	Instance		
0Eh	Yes	Yes	Get_Attribute_Single	returns contents of specified attribute
01h	Yes	Yes	Get_Attributes_All	returns predefined listing of object attributes
10h	No	Yes	Set_Attribute_Single	modifies attribute
4Bh	No	Yes	Get_Enum_String	reads enumerated strings from parameter instance

Class ID 0x10 Parameter Group Object

Instance Attributes

Attribute	Access Rule	Name	Data Type	Description	Contents
1	Get	Group Name String	SHORT_STRING	represents group name	Name of Group from Drive
2	Get	Number of group members	UINT	amount of parameters in group	value of n

3	Get	1 st group parameter (000-099)	UINT	instance number of Parameter Object	variable
4	Get	2 nd group parameter (100-199)	UINT	instance number of Parameter Object	variable
...	Get	...	UINT	...	variable
n+2	Get	n th group parameter	UINT	instance number of Parameter Object	variable

Class ID 0x64 – 0xC7 Danfoss Objects

The CIP Class ID 100 to 199 (0x64 to 0xC7) gives access to all drive parameters.

Class (decimal)	Danfoss Parameter range
100	0-01 - 0-99
101	1-00 – 1-99
102	2-00 – 2-99
103	3-00 – 3-99
104	4-00 – 4-99
105	5-00 – 5-99
106	6-00 – 6-99
107	7-00 – 7-99
108	8-00 – 8-99
109	9-00 – 9-99
110	10-00 – 10-99
111	11-00 – 11-99
...	...
199	99-00 – 99-99

The class Instance and Attribute acts in the following way:

- 100 added to the parameter group = the value for the class.
- 100 added to the remaining parameter number = the value for the instance.
- 100 added to the array index of the parameter = the value for the attribute.

Examples: (fictitious parameters)

- Parameter 0-01[index 0] = Class 100; Instance 101; Attribute 100
- Parameter 1-00[index 0] = Class 101; Instance 100; Attribute 100
- Parameter 2-59[index 0] = Class 102; Instance 159; Attribute 100
- Parameter 5-34[index 3] = Class 105; Instance 134; Attribute 103
- Parameter 6-54[index 9] = Class 106; Instance 154; Attribute 109
- Parameter 10-01[index 0] = Class 110; Instance 101; Attribute 100

All values in decimal.

All parameters are accessed in the Active setup (par. 0-10 *Active Setup*)

Service Code	Implemented		Service Name	Service Description
	Class	Instance		
0Eh	Yes	Yes	Get_Attribute_Single	returns contents of specified attribute
10h	No	Yes	Set_Attribute_Single	modifies attribute
4Bh	No	Yes	Get_Att_Scattered	returns specified parameter values
4Ch	No	Yes	Set_Att_Scattered	sets specified parameter values

Index

A		M	
Abbreviations	6	Master	17
AC/DC drive object	54	Motor data object	52
Alarm word	46-50	Multicast	19
Appendix	51	N	
Assembly object	51	Network	10
Assembly instances	20	O	
Assumptions	5	Object model	51
B		ODVA conformance	5
Background Knowledge	5	ODVA profile	28
C		Overview (technical)	5
Cable length	11	P	
Cabling	11	Parameter access	59
Change-Of-State	23	Parameter group object	57
CIP objects	51	Parameter object	56
Class 1 connection	21	Parameters	32-43
Class 3 connection	22	R	
Configuration	14-19	Reference	30
Conversion index	44	Rockwell master	17
Control supervisor object	53	S	
D		Safety	3
Danfoss objects	59	Spanning Tree	19
Data types	44	T	
E		Topology	10
EDS	17	Trouble shooting	45
EMC precautions	13	U	
Ethernet	4, 14	Unconnected message	22
EtherNet/IP	4, 14	W	
F		Warning word	48-50
FC profile	24		
Forward Open	21		
H			
Hardware	5, 7		
I			
I/O	20		
Identity object	51		
IGMP	19		
Installation	8		
Interface object	55		
IP settings	14		
IP traffic	19		
L			
Link object	55		
Literature	5		
LEDs	9		