

HARDWARE REFERENCE MANUAL

PMAC2A-PC/104

PMAC2A-PC/104 Hardware Reference Manual

4xx-603670-xHxx

September 22, 2004



DELTA TAU
Data Systems, Inc.

NEW IDEAS IN MOTION ...

Copyright Information

© 2003 Delta Tau Data Systems, Inc. All rights reserved.

This document is furnished for the customers of Delta Tau Data Systems, Inc. Other uses are unauthorized without written permission of Delta Tau Data Systems, Inc. Information contained in this manual may be updated from time-to-time due to product improvements, etc., and may not conform in every respect to former issues.

To report errors or inconsistencies, call or email:

Delta Tau Data Systems, Inc. Technical Support

Phone: (818) 717-5656

Fax: (818) 998-7807

Email: support@deltatau.com

Website: <http://www.deltatau.com>

Operating Conditions

All Delta Tau Data Systems, Inc. motion controller products, accessories, and amplifiers contain static sensitive components that can be damaged by incorrect handling. When installing or handling Delta Tau Data Systems, Inc. products, avoid contact with highly insulated materials. Only qualified personnel should be allowed to handle this equipment.

In the case of industrial applications, we expect our products to be protected from hazardous or conductive materials and/or environments that could cause harm to the controller by damaging components or causing electrical shorts. When our products are used in an industrial environment, install them into an industrial electrical cabinet or industrial PC to protect them from excessive or corrosive moisture, abnormal ambient temperatures, and conductive materials. If Delta Tau Data Systems, Inc. products are exposed to hazardous or conductive materials and/or environments, we cannot guarantee their operation.

Table of Contents

INTRODUCTION	1
Board Configuration.....	1
<i>Base Version</i>	1
<i>Option 2A: PC/104 Bus Stack Interface</i>	1
<i>Option 5xF: CPU Speed Options</i>	1
<i>Option 6: Extended Firmware Algorithm</i>	1
<i>Option 6L: Multi-block Lookahead Firmware</i>	1
<i>Option 10: Firmware Version Specification</i>	1
<i>Option 12: Analog-to-Digital Converters</i>	2
<i>Acc-1P: Axis Expansion Piggyback Board</i>	2
<i>Acc-1P Option 1: I/O Ports</i>	2
<i>Acc-1P Option 2: Analog-to-Digital Converters</i>	2
<i>Acc-2P: Communications Board</i>	3
<i>Acc-2P Option 1A: USB Interface</i>	3
<i>Acc-2P Option 1B: Ethernet Interface</i>	3
<i>Acc-2P Option 2: DPRAM Circuitry</i>	3
<i>Acc-2P Option 3: I/O Ports</i>	3
<i>Acc-8TS Connections Board</i>	3
<i>Acc-8ES Four-Channel Dual-DAC Analog Stack Board</i>	3
<i>Acc-8FS Four-Channel Direct PWM Stack Breakout Board</i>	3
BASE BOARD HARDWARE SETUP	5
Clock Configuration Jumpers.....	5
Board Reset Jumpers	5
CPU Jumper Configuration	6
Communication Jumpers.....	6
I/O Configuration Jumpers	6
Resistor Packs Configuration	6
<i>Differential or Single-Ended Encoder Selection</i>	6
ACC-1P HARDWARE SETUP	9
I/O Configuration Jumpers	9
Reserved Configuration Jumpers	9
Resistor Packs Configuration	9
<i>Differential or Single-Ended Encoder Selection</i>	9
<i>Handwheel Encoder Termination Resistors</i>	10
ACC-2P HARDWARE SETUP.....	11
I/O Configuration Jumpers	11
Communication Jumpers.....	11
Resistor Packs Configuration	12
<i>Differential or Single-Ended Handwheel Encoder Selection</i>	12
<i>Handwheel Encoder Termination Resistors</i>	12
MACHINE CONNECTIONS.....	13
Mounting.....	13
Power Supplies	13
<i>Digital Power Supply</i>	13
<i>DAC Outputs Power Supply</i>	13
<i>Flags Power Supply</i>	14
Overtravel Limits and Home Switches.....	14
<i>Types of Overtravel Limits</i>	14
<i>Home Switches</i>	14
Motor Signals Connections	14
<i>Incremental Encoder Connection</i>	14

<i>DAC Output Signals</i>	15
<i>Pulse and Direction (Stepper) Drivers</i>	15
<i>Amplifier Enable Signal (AENAx/DIRn)</i>	15
<i>Amplifier Fault Signal (FAULT-)</i>	16
Acc-1P General-Purpose Digital Inputs and Outputs (J7 Port)	16
Acc-2P General-Purpose Digital Inputs and Outputs (JOPT Port).....	17
Acc-1P Thumbwheel Multiplexer Port (J2 Port).....	17
Acc-2P Thumbwheel Multiplexer Port (JTHW Port).....	17
Acc-1P or Acc-2P Handwheel Port (JHW / PD Port)	18
Optional Analog Inputs	18
Compare Equal Outputs	18
Serial Port (JRS232 Port)	19
Acc-2P Ethernet RJ45 Connector (J10 Port).....	19
Acc-2P USB Connector (J1 Port).....	19
Machine Connections Example: Using Analog $\pm 10V$ Amplifier	20
Machine Connections Example: Using Pulse and Direction Drivers	21
SOFTWARE SETUP	23
Communications.....	23
PMAC I-Variables.....	23
Operational Frequency and Baud Rate Setup.....	23
Filtered DAC Outputs Configuration	24
Using Flag I/O as General-Purpose I/O.....	25
General-Purpose Digital Inputs and Outputs.....	25
<i>Acc-1P with Jumper E6 on Position 1-2</i>	25
<i>Acc-2P with Jumper E5 in Position 2-3</i>	26
Thumbwheel Port Digital Inputs and Outputs.....	27
<i>Acc-1P with Jumper E6 in Position 1-2</i>	27
<i>Acc-2P with Jumper E5 in Position 2-3</i>	27
Analog Inputs Setup.....	28
<i>Baseboard Analog Inputs</i>	28
<i>Acc-1P Analog Inputs</i>	28
BASE BOARD HARDWARE REFERENCE SUMMARY	29
Board Dimensions	29
Board Layout.....	30
Connectors and Indicators	31
<i>J3 - Machine Connector (JMACH1 Port)</i>	31
<i>J4 - Machine Connector (JMACH2 Port)</i>	31
<i>J8 - Serial Port (JRS232 Port)</i>	31
<i>TB1 – Power Supply Terminal Block (JPWR Connector)</i>	31
<i>LED Indicators</i>	31
ACC-1P HARDWARE REFERENCE SUMMARY	33
Board Dimensions	33
Board Layout.....	34
Connectors and Indicators	35
<i>J2 - Thumbwheel Multiplexer Port (JTHW Port)</i>	35
<i>J3 - Machine Connector (JMACH1 Port)</i>	35
<i>J4 - Machine Connector (JMACH2 Port)</i>	35
<i>J7 - General-Purpose Digital Inputs and Outputs (JOPT Port)</i>	35
<i>J8 – Handwheel / Pulse and Direction Port (JHW / PD Port)</i>	35
<i>TB1 – Power Supply Terminal Block (JPWR Connector)</i>	35
ACC-2P HARDWARE REFERENCE SUMMARY	37
Board Dimensions	37
Board Layout.....	38
Connectors and Indicators	39

J1 – USB Communications Port	39
J2 - Thumbwheel Multiplexer Port (JTHW Port)	39
J7 - General-Purpose Digital Inputs and Outputs (JOPT Port).....	39
J8 – Handwheel/Pulse and Direction Port (JHW / PD Port).....	39
J10 – Ethernet Communications Port.....	39
TB1 – Power Supply Terminal Block (JPWR Connector)	39
LED Indicators	39
BASE BOARD E-POINT JUMPER DESCRIPTIONS	41
E0: Forced Reset Control	41
E1: Servo and Phase Clock Direction Control	41
E2: CPU Frequency Select	41
E3: Normal/Re-Initializing Power-Up/Reset.....	41
E4: CPU Frequency Select	42
E8: Phase Clock Lines Output Enable.....	42
E9: Servo Clock Lines Output Enable.....	42
E10 – E12: Power-Up State Jumpers	42
E13: Power-Up/Reset Load Source.....	43
E14: Watchdog Disable Jumper	43
E15A, B, C: Flash Memory Bank Select.....	43
E16:	43
ADC Inputs Enable	43
E18 – E19: PC/104 Bus Address.....	44
ACC-1P E-POINT JUMPER DESCRIPTIONS.....	45
E0: Reserved for Future Use	45
E1 - E2: Machine Output Supply Voltage Configure.....	45
E3 – E4: JHW, PD Function Select.....	45
E5: Servo Gate Address Select.....	46
E6: I/O Gate Address Select.....	46
E7: Machine Input Source/Sink Control	46
E16: ADC Inputs Enable.....	46
ACC-2P E-POINT JUMPER DESCRIPTIONS.....	47
E1: USB/Ethernet Micro-Controller Firmware Reload Enable.....	47
E3 – E4: JHW, PD Function Select.....	47
E5: I/O Gate Address Select.....	47
E6: Communications Port Select.....	47
E7- E10: Ports Direction Control	48
BASE BOARD CONNECTOR PINOUTS.....	49
TB1 (JPWR): Power Supply	49
ACC-1P CONNECTOR PINOUTS	53
TB1 (JPWR): Power Supply	53
J2 (JTHW): Multiplexer Port Connector	54
J3 (JMACH1): Machine Port Connector (50-Pin Header)	55
J4 (JMACH2): Machine Port Connector (34-Pin Header)	57
J7 (JOPTO): I/O Port Connector.....	58
J8 (JHW) Handwheel Encoder Connector.....	59
ACC-2P CONNECTOR PINOUTS	61
TB1 (JPWR): Power Supply	61
J1 (USB) Universal Serial Bus Port (Optional).....	61
J2 (JTHW): Multiplexer Port Connector.....	62
J7 (JOPT): I/O Port Connector	63
J8 (JHW) Handwheel Encoder Connector.....	64
J10 Ethernet Port (Optional).....	64

INTRODUCTION

The PMAC2A PC/104 motion controller is a compact, cost-effective version of the Delta Tau's PMAC2 family of controllers. The PMAC2A PC/104 can be composed of three boards in a stack configuration.

The baseboard provides four channels of either DAC $\pm 10V$ or pulse and direction command outputs. The optional axis expansion board provides a set of four additional servo channels and I/O ports. The optional communications board provides extra I/O ports and either the USB or Ethernet interface for faster communications.

Board Configuration

Base Version

The base version of the PMAC2A PC/104 ordered with no options provides a 90mm x 95mm board with:

- 40 MHz DSP563xx CPU (80 MHz 560xx equivalent)
- 128k x 24 internal zero-wait-state SRAM
- 512k x 8 flash memory for user backup and firmware
- Latest released firmware version
- RS-232 serial interface
- Four channels axis interface circuitry, each including:
 - 12-bit $\pm 10V$ analog output
 - Pulse-and-direction digital outputs
 - 3-channel differential/single-ended encoder input
 - Four input flags, two output flags
 - Three PWM top-and-bottom pairs (unbuffered)
- 50-pin IDC header for amplifier/encoder interface
- 34-pin IDC header for flag interface
- PID/notch/feedforward servo algorithms
- 1-year warranty from date of shipment
- One CD-ROM per set of one to four PMACs in shipment (Cables, mounting plates, mating connectors not included)

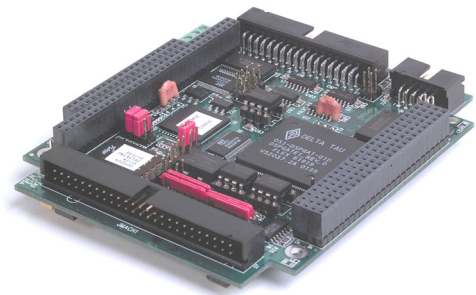

PMAC2A-PC/104 Base Board shown

Option 2A: PC/104 Bus Stack Interface

Option 2A provides the PC/104 bus interface allowing bus communications between a PC/104 type computer and the PMAC2A PC/104 motion controller.

Option 5xF: CPU Speed Options

- Option 5CF: 80 MHz DSP563xx CPU (160 MHz 56002 equivalent)
- Option 5EF: 160 MHz DSP563xx CPU (320 MHz 56002 equivalent)

Option 6: Extended Firmware Algorithm

Option 6 provides an Extended (Pole-Placement) Servo Algorithm firmware instead of the regular servo algorithm firmware. This is required only in difficult-to-control systems (resonances, backlash, friction, disturbances, changing dynamics).

Option 6L: Multi-block Lookahead Firmware

Option 6L provides a special lookahead firmware for sophisticated acceleration and cornering profiles execution. With the lookahead firmware PMAC controls the speed along the path automatically (but without changing the path) to ensure that axis limits are not violated.

Option 10: Firmware Version Specification

Normally the PMAC PCI Lite is provided with the newest released firmware version. A label on the memory IC shows the firmware version loaded at the factory. Option 10 provides for a user-specified firmware version.

Option 12: Analog-to-Digital Converters

Option 12 permits the installation of two channels of on-board analog-to-digital converters with $\pm 10V$ input range and 12-bits resolution. The key component installed with this option is U20.

Acc-1P: Axis Expansion Piggyback Board

Acc-1P provides four additional channels axis interface circuitry for a total of eight servo channels, each including:

- 12-bit $\pm 10V$ analog output
- Pulse-and-direction digital outputs
- 3-channel differential/single-ended encoder input
- Four input flags, two output flags
- Three PWM top-and-bottom pairs (unbuffered)

Acc-1P Option 1: I/O Ports

Option 1 provides the following ports on the Acc-1P axes expansion board for digital I/O connections.

- Multiplexer Port: This connector provides eight input lines and eight output lines at TTL levels. When using the PMAC Acc-34x type boards these lines allow multiplexing large numbers of inputs and outputs on the port. Up to 32 of the multiplexed I/O boards may be daisy-chained on the port, in any combination.
- I/O Port: This port provides eight general-purpose digital inputs and eight general-purpose digital outputs at 5 to 24Vdc levels. This 34-pin connector was designed for easy interface to OPTO-22 or equivalent optically isolated I/O modules when different voltage levels or opto-isolation to the PMAC2A PC/104 is necessary.
- Handwheel port: this port provides two extra channels, each jumper selectable between encoder input or pulse output.

Acc-1P Option 2: Analog-to-Digital Converters

Option 2 permits the installation on the Acc-1P of two channels of analog-to-digital converters with $\pm 10V$ input range and 12-bits resolution. The key component installed with this option is U20.

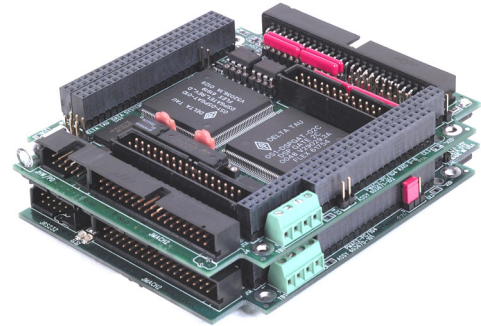

PMAC2A PC/104 Base Board shown stacked with the Acc-1P axes

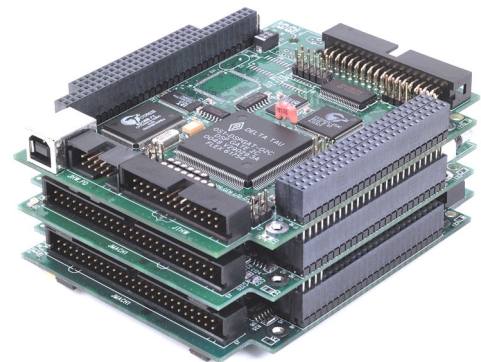

PMAC2A PC/104 Base Board shown stacked with the Option-1P and Option-2P boards

Acc-2P: Communications Board

Without any options, the PMAC2A PC/104 communicates through the RS-232 serial interface using the optional Acc-3L flat cable. Only one method of communication is allowed at a time.

Acc-2P Option 1A: USB Interface

Option 1A it provides a 12 Mbit/sec USB interface allowing USB communications with the PMAC2A PC/104 motion controller.

Acc-2P Option 1B: Ethernet Interface

Option 1B provides a 10 Mbit/sec Ethernet interface allowing Ethernet communications with the PMAC2A PC/104 motion controller.

Acc-2P Option 2: DPRAM Circuitry

Option 2 provides an 8K x 16 dual-ported RAM for USB, Ethernet or PC/104 ports on board of the Acc-2P communications board. If using for USB or Ethernet communications, Acc-2P-Opt-1A or Acc-2P-Opt-1B must be ordered. If used for PC/104-bus communications, PMAC2A PC/104 Option-2A must be ordered. The key component installed with this option is U17.

Acc-2P Option 3: I/O Ports

Option 3 provides the following ports on the Acc-2P communications board for digital I/O connections.

- Multiplexer Port: this connector provides eight input lines and eight output lines at TTL levels. When using the PMAC Acc-34x type boards these lines allow multiplexing large numbers of inputs and outputs on the port. Up to 32 of the multiplexed I/O boards may be daisy-chained on the port, in any combination.
- I/O Port: this port provides 16 general-purpose digital I/O lines at TTL levels and these can be configured as all inputs, all outputs or eight inputs and eight outputs.
- Handwheel port: this port provides two extra channels, each jumper selectable between encoder input or pulse output.

Acc-8TS Connections Board

Acc-8TS is a stack interface board to for the connection of either one or two Acc-28B A/D converter boards. When a digital amplifier with current feedback is used, the analog inputs provided by the Acc-28B cannot be used.

Acc-8ES Four-Channel Dual-DAC Analog Stack Board

Acc-8ES provides four channels of 18-bit dual-DAC with four DB-9 connectors. This accessory is stacked to the PMAC2A PC/104 board and it is mostly used with amplifiers that require two ± 10 V command signals for sinusoidal commutation.

Acc-8FS Four-Channel Direct PWM Stack Breakout Board

Acc-8FS it is a 4-channel direct PWM stack breakout board for PMAC2A PC/104. This is used for controlling digital amplifiers that require direct PWM control signals. When a digital amplifier with current feedback is used, the analog inputs provided by the Option 12 of the PMAC2A PC/104 (the Option 2 of the Acc-1P or the Acc-28B) could not be used.

BASE BOARD HARDWARE SETUP

On the PMAC2 PC/104 baseboard, there are many jumpers (pairs of metal prongs) called E-points or W-points. Some have been shorted together; others have been left open. These jumpers customize the hardware features of the baseboard for a given application and must be setup appropriately. The following is an overview of the several jumpers grouped in appropriate categories. For a complete description of the jumper setup configuration, refer to the E-Point Descriptions section.

Clock Configuration Jumpers

E1: Servo and Phase Clock Direction Control – Jumper E1 should be OFF if the board is to use its own internally generated phase and servo clock signals. In this case, these signals are output on spare pins on the J8 RS-232 serial-port connector, where they can be used by other PMAC controllers set up to take external phase and servo clock signals.

Jumper E1 should be ON if the board is to use externally generated phase and servo clock signals brought in on the J8 RS-232 serial port connector. In this case, typically the clock signals are generated by another PMAC controller and output on its serial port connector.

If E1 is ON for external phase and clock signals, and these clock signals are not brought in on the serial port connector, the watchdog timer will trip almost immediately and shut down the board.

E2 and E4: CPU Frequency Control Jumpers – When the PMAC I46 I- variable is set to zero jumpers E2 and E4 on the base PMAC2A PC/104 board control the frequency at which the CPU will operate (or attempt to operate). Generally, this will be the highest frequency at which the CPU is rated to operate. Note that it is always possible to operate a CPU at a frequency lower than its maximum rating. While it may be possible to operate an individual processor at a frequency higher than its maximum rating, particularly at low ambient temperatures, performance cannot be guaranteed at such a setting, and this operation is done completely at the user's own risk.

- If jumpers E2 and E4 are both OFF, the CPU will operate at a 40 MHz frequency.
- If E2 is ON and E4 is OFF, the CPU will operate at a 60 MHz frequency.
- If E2 is OFF and E4 is ON, the CPU will operate at an 80 MHz frequency.

If I46 is set to a value greater than 0, the operational frequency is set to $10\text{MHz} * (I46 + 1)$, regardless of the jumper setting. See the Software Setup section for details on this.

E8: Phase Clock Lines Output Enable – Jump pin 1 to 2 to enable the Phase clock line on the J8 connector. Remove jumper to disconnect the Phase clock line on the J8 connector.

E9: Servo Clock Lines Output Enable – Jump pin 1 to 2 to enable the Servo clock line on the J8 connector. Remove jumper to disconnect the Servo clock line on the J8 connector.

Board Reset Jumpers

E0: Forced Reset Control – Remove E0 for normal operation. Installing E0 forces PMAC to a reset state, and this configuration is for factory use only; the board will not operate with E0 installed.

E3: Re-Initialization on Reset Control – If E3 is OFF (default), PMAC executes a normal reset, loading active memory from the last saved configuration in non-volatile flash memory. If E3 is ON, PMAC re-initializes on reset, loading active memory with the factory default values.

E13: Firmware Load Jumper – If jumper E13 is ON during power-up/reset, the board comes up in bootstrap mode which permits the loading of new firmware into the flash-memory IC on the board. When the PMAC Executive program tries to establish communications with a board in this mode, it will detect automatically that the board is in bootstrap mode and ask what file to download as the new firmware.

Jumper E13 must be OFF during power-up/reset for the board to come up in normal operational mode.

CPU Jumper Configuration

E15A-E15C: Flash Memory Bank Select Jumpers – The flash-memory IC in location U10 on the PMAC2A PC/104 base board has the capacity for eight separate banks of firmware, only one of which can be used at any given time. The eight combinations of settings for jumpers E15A, E15B, and E15C select which bank of the flash memory is used. In the factory production process, firmware is loaded only into Bank 0, which is selected by having all of these jumpers OFF.

E10-E12: Power-Up State Jumpers – Jumper E10 must be OFF, jumper E11 must be ON, and jumper E12 must be ON, in order for the CPU to copy the firmware from flash memory into active RAM on power-up/reset. This is necessary for normal operation of the card. (Other settings are for factory use only.)

E14: Watchdog Timer Jumper – Jumper E14 must be OFF for the watchdog timer to operate. This is a very important safety feature, so it is vital that this jumper be OFF in normal operation. E14 should only be put ON to debug problems with the watchdog timer circuit.

W1: Flash chip select – Jumper W1 in position 1-2 selects a 28F320J3A part for the U10 flash chip. Jumper W1 in position 2-3 selects a 28F320J5A part for the U10 flash chip. This jumper is installed in the factory and must not be changed from its default state.

Communication Jumpers

E18-E19: PC/104 Bus Base Address Control – Jumpers E18 and E19 on the PMAC2A PC/104 baseboard determine the base address of the card in the I/O space of the host PC's bus. Together, they specify four consecutive addresses on the bus where the card can be found. The jumpers form the base address in the following fashion:

E18	E19	Address (hex)	Address (dec)
OFF	OFF	\$200	512
OFF	ON	\$210	528
ON	OFF	\$220	544
ON	ON	\$230	560

The default base address is 528 (\$210) formed with jumper E18 removed and E19 installed. This configuration is necessary for using the USB or Ethernet ports of the Acc-2P communications board.

I/O Configuration Jumpers

E16: ADC Enable Jumper – Install E16 to enable the analog-to-digital converter circuitry ordered through Option-12. Remove this jumper to disable this option, which might be necessary to control motor 1 through a digital amplifier with current feedback.

Resistor Packs Configuration

Differential or Single-Ended Encoder Selection

The differential input signal pairs to the PMAC have user-configurable pull-up/pull-down resistor networks to permit the acceptance of either single-ended or differential signals in one setting, or the detection of lost differential signals in another setting.

The '+' inputs of each differential pair each have a hard-wired 1 kΩ pull-up resistor to +5V. This cannot be changed.

The '-' inputs of each differential pair each have a hard-wired 2.2 kΩ resistor to +5V; each also has another 2.2 kΩ resistor as part of a socketed resistor pack that can be configured as a pull-up resistor to +5V, or a pull-down resistor to GND.

If this socketed resistor is configured as a pull-down resistor (the default configuration), the combination of pull-up and pull-down resistors on this line acts as a voltage divider, holding the line at +2.5V in the absence of an external signal. This configuration is required for single-ended inputs using the '+' lines alone; it is desirable for unconnected inputs to prevent the pick-up of spurious noise; it is permissible for differential line-driver inputs.

If this socketed resistor is configured as a pull-up resistor (by reversing the SIP pack in the socket), the two parallel 2.2 k Ω resistors act as a single 1.1 k Ω pull-up resistor, holding the line at +5V in the absence of an external signal. This configuration is required if complementary open-collector drivers are used; it is permissible for differential line-driver inputs.

If Pin 1 of the resistor pack, marked by a dot on the pack, matches Pin 1 of the socket, labeled by a white square, then the pack is configured as a bank of pull-down resistors. If the pack is reversed in the socket, it is configured as a bank of pull-up resistors.

The following table lists the pull-up/pull-down resistor pack for each input device:

Device	Resistor Pack	Pack Size
Encoder 1	RP30	6-pin
Encoder 2	RP31	6-pin
Encoder 3	RP36	6-pin
Encoder 4	RP37	6-pin

ACC-1P HARDWARE SETUP

On the Acc-1P, you will see many jumpers (pairs of metal prongs), called E-points. Some have been shorted together; others have been left open. These jumpers customize the hardware features of the Acc-1P for a given application and must be setup appropriately. The following is an overview of the several jumpers grouped in appropriate categories. For a complete description of the jumper setup configuration, refer to the Acc-1P E-Point Description section.

I/O Configuration Jumpers

E1-E2: Machine Output Supply Configure – With the default sinking output driver IC (ULN2803A or equivalent) in U7 for the J7 JOPT port outputs, these jumpers must connect pins 1 and 2 to supply the IC correctly. If this IC is replaced with a sourcing output driver IC (UDN2981A or equivalent), these jumpers must be changed to connect pins 2 and 3 to supply the new IC correctly. A wrong setting of these jumpers will damage the associated output IC.

E3-E4: JHW, PD Function Select – When jumper E3 connects pins 2 and 3, a set of pulse and direction signals can be output on channel 1 (pins 2 to 5) of the JHW, PD port. If E3 connects pins 1 and 2, then channel 1 is configured as a handwheel encoder input. When jumper E4 connects pins 2 and 3, a set of pulse and direction signals can be output on channel 2 (pins 6 to 9) of the JHW, PD port. If E4 connects pins 1 and 2, then channel 2 is configured as a handwheel encoder input.

E5: Servo Gate address select – If jumper E5 connects pins 1 and 2 (default) the servo channels on the Acc-1P will be accessed at the regular addresses for motors 5 to 8. When E5 connects pins 2 and 3 the servo channels on the Acc-1P board will be accessed at the regular addresses for motors 5 to 8 plus \$40, and this is useful only when two Acc-1Ps are used with the same PMAC2A PC/104 baseboard.

E6: I/O Gate address select – If jumper E6 connects pins 1 and 2 (default) the I/O features on the Acc-1P will be accessed at the regular addresses and the JTHW port can be used as a multiplexer port. When E6 connects pins 2 and 3 the I/O features on the Acc-1P board will be accessed at the regular addresses plus \$40, and this is useful only when two Acc-1P are used with the same PMAC2A PC/104 baseboard.

E7: Machine Input Source/Sink Control – With this jumper connecting pins 1 and 2 (default) the machine input lines on the J7 JOPT port are pulled up to +5V or the externally provided supply voltage for the port. This configuration is suitable for sinking drivers. If the jumper is changes to connect pins 2 and 3, these lines are pulled down to GND – this configuration is suitable for sourcing drivers.

E16: ADC Enable Jumper – Install E16 to enable the analog-to-digital converter circuitry ordered through Option-2. Remove this jumper to disable this option, which might be necessary to control motor 5 through a digital amplifier with current feedback.

Reserved Configuration Jumpers

E0: Reserved for future use

Resistor Packs Configuration

Differential or Single-Ended Encoder Selection

The differential input signal pairs to the PMAC have user-configurable pull-up/pull-down resistor networks to permit the acceptance of either single-ended or differential signals in one setting, or the detection of lost differential signals in another setting.

The '+' inputs of each differential pair each have a hard-wired 1 k Ω pull-up resistor to +5V. This cannot be changed.

The ‘-‘ inputs of each differential pair each have a hard-wired 2.2 kΩ resistor to +5V; each also has another 2.2 kΩ resistor as part of a socketed resistor pack that can be configured as a pull-up resistor to +5V, or a pull-down resistor to GND.

If this socketed resistor is configured as a pull-down resistor (the default configuration), the combination of pull-up and pull-down resistors on this line acts as a voltage divider, holding the line at +2.5V in the absence of an external signal. This configuration is required for single-ended inputs using the ‘+’ lines alone; it is desirable for unconnected inputs to prevent the pick-up of spurious noise; it is permissible for differential line-driver inputs.

If this socketed resistor is configured as a pull-up resistor (by reversing the SIP pack in the socket), the two parallel 2.2 kΩ resistors act as a single 1.1 kΩ pull-up resistor, holding the line at +5V in the absence of an external signal. This configuration is required if complementary open-collector drivers are used; it is permissible for differential line-driver inputs.

If Pin 1 of the resistor pack, marked by a dot on the pack, matches Pin 1 of the socket, labeled by a white square, then the pack is configured as a bank of pull-down resistors. If the pack is reversed in the socket, it is configured as a bank of pull-up resistors. The following table lists the pull-up/pull-down resistor pack for each input device:

Device	Resistor Pack	Pack Size
Encoder 1	RP30	6-pin
Encoder 2	RP31	6-pin
Encoder 3	RP36	6-pin
Encoder 4	RP37	6-pin
Handwheel Encoder	RP55	6-pin

Handwheel Encoder Termination Resistors

The PMAC provides a socket for termination resistors on the handwheel encoder differential input pairs coming into the board. As shipped, there is no resistor pack in the RP56 socket. If these signals are brought long distances into the PMAC board and ringing at signal transitions is a problem, a SIP resistor pack may be mounted on the RP56 socket to reduce or eliminate the ringing. The 6-pin termination resistor pack is the type that has independent resistors (no common connection) with each resistor using 2 adjacent pins.

ACC-2P HARDWARE SETUP

On the Acc-2P, there are many jumpers (pairs of metal prongs), called E-points. Some have been shorted together; others have been left open. These jumpers customize the hardware features of the Acc-2P for a given application and must be setup appropriately. The following is an overview of the several jumpers grouped in appropriate categories. For a complete description of the jumper setup configuration, refer to the Acc-2P E-Point Descriptions chapter.

I/O Configuration Jumpers

E3-E4: JHW, PD Function Select – When jumper E3 connects pins 2 and 3, a set of pulse and direction signals can be output on channel 1 (pins 2 to 5) of the JHW, PD port. If E3 connects pins 1 and 2, then channel 1 is configured as a handwheel encoder input. When jumper E4 connects pins 2 and 3, a set of pulse and direction signals can be output on channel 2 (pins 6 to 9) of the JHW, PD port. If E4 connects pins 1 and 2, then channel 2 is configured as a handwheel encoder input.

E5: I/O Gate address select – If jumper E5 connects pins 1 and 2 the I/O features on the Acc-2P will be accessed at the regular addresses and the JTHW port can be used as a multiplexer port. When E5 connects pins 2 and 3 the I/O features on the Acc-2P board will be accessed at the regular addresses plus \$40, and this is necessary only when both Acc-2P and Acc-1P are used with the same PMAC2A PC/104 baseboard.

E7-E10: Ports Direction Control – These jumpers select the I/O lines direction of the JTHW and the JOPT connectors. This allows configuring these ports as all inputs, all outputs or half inputs and half outputs according to the following tables:

JTHW Connector			
E7	E8	DATx lines	SELx lines
OFF	OFF	Output	Output
OFF	ON	Output	Input
ON	OFF	Input	Output
ON	ON	Input	Input

JOPT Connector			
E9	E10	MOx lines	MIx Lines
OFF	OFF	Output	Output
OFF	ON	Output	Input
ON	OFF	Input	Output
ON	ON	Input	Input

If E7 is removed or E8 is installed then the multiplexing feature if the JTHW port cannot be used.

Communication Jumpers

E1: USB/Ethernet Micro Controller Firmware reload enable – This jumper was added on revision – 103 and above of the Acc-2P. Factory default position is ON, and it should remain ON. If the firmware was corrupted due to a previous firmware download, the card firmware may be reloaded by powering on the card with the jumper off, installing the jumper without powering off, then downloading firmware with out powering off. Under normal circumstances, this jumper should be on even when upgrading firmware.

E6: Communications Port Selection – When jumper E6 connects pins 1 and 2 the PC/104 communications port is enabled. If E6 connects pins 2 and 3 the Ethernet or USB ports are enabled. Only one port can be used at a time. If either the Ethernet or USB ports are used then jumper E19 on the base board must be installed and jumper E18 on the base board must be removed. In order to communicate through the RS-232 serial port jumper E6 must be installed, either in position 1-2 or 2-3.

Resistor Packs Configuration

Differential or Single-Ended Handwheel Encoder Selection

The handwheel encoder differential input signal pairs to the PMAC have user-configurable pull-up/pull-down resistor networks to permit the acceptance of either single-ended or differential signals in one setting, or the detection of lost differential signals in another setting.

The '+' inputs of each differential pair each have a hard-wired 1 k Ω pull-up resistor to +5V. This cannot be changed.

The '-' inputs of each differential pair each have a hard-wired 2.2 k Ω resistor to +5V; each also has another 2.2 k Ω resistor as part of a socketed resistor pack that can be configured as a pull-up resistor to +5V, or a pull-down resistor to GND.

If this socketed resistor is configured as a pull-down resistor (the default configuration), the combination of pull-up and pull-down resistors on this line acts as a voltage divider, holding the line at +2.5V in the absence of an external signal. This configuration is required for single-ended inputs using the '+' lines alone; it is desirable for unconnected inputs to prevent the pick-up of spurious noise; it is permissible for differential line-driver inputs.

If this socketed resistor is configured as a pull-up resistor (by reversing the SIP pack in the socket), the two parallel 2.2 k Ω resistors act as a single 1.1 k Ω pull-up resistor, holding the line at +5V in the absence of an external signal. This configuration is required if complementary open-collector drivers are used; it is permissible for differential line-driver inputs.

If Pin 1 of the resistor pack, marked by a dot on the pack, matches Pin 1 of the socket, labeled by a white square, then the pack is configured as a bank of pull-down resistors. If the pack is reversed in the socket, it is configured as a bank of pull-up resistors.

RP22 is the 6-pin pull-up/pull-down resistor pack for the handwheel encoder input.

Handwheel Encoder Termination Resistors

The PMAC provides a socket for termination resistors on the handwheel encoder differential input pairs coming into the board. As shipped, there is no resistor pack in the RP23 socket. If these signals are brought long distances into the PMAC board and ringing at signal transitions is a problem, a SIP resistor pack may be mounted on the RP23 socket to reduce or eliminate the ringing. The 6-pin termination resistor pack is the type that has independent resistors (no common connection) with each resistor using two adjacent pins.

MACHINE CONNECTIONS

Typically, the user connections are actually made to terminal blocks that are attached to the JMACH connectors by a flat cable. The following are the terminal blocks recommended for connections:

- 34-Pin IDC header to terminal block breakouts (Phoenix part number 2281063) Delta Tau part number 100-FLKM34-000
- 50-Pin IDC header to terminal block breakouts (Phoenix part number 2281089) Delta Tau part number 100-FLKM50-000

Mounting

The PMAC2A PC/104 is always installed either using standoffs, when it is stacked to a PC/104 computer or used as a stand-alone controller. At each of the four corners of the PMAC2A PC/104 board, there are mounting holes that can be used to mount the board on standoffs.

The PMAC2A PC/104 baseboard is placed always at the bottom of the stack. The order of the Acc-1P or Acc-2P with respect to the baseboard does not matter.

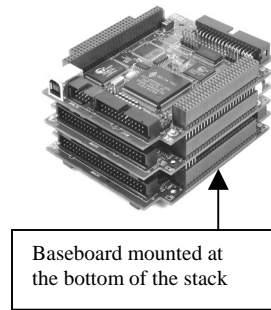

Power Supplies

Digital Power Supply

3A @ +5V ($\pm 5\%$) (15 W)

(Eight-channel configuration, with a typical load of encoders)

The PMAC2A PC/104, the Acc-1P and the Acc-2P each require a 1A @ 5VDC power supply for operation. Therefore, a 3A @ 5VDC power supply is recommended for a PMAC2A PC/104 board stack with Acc-1P and Acc-2P boards.

- The host computer provides the 5 Volts power supply in the case PMAC is installed in the PC/104 bus. With the board stack into the bus, it will automatically pull +5V power from the bus and it cannot be disconnected. In this case, there must be no external +5V supply, or the two supplies will "fight" each other, possibly causing damage. This voltage could be measured on the TB1 terminal block or the JMACH1 connector.
- In a stand-alone configuration, when PMAC is not plugged in a computer bus, it will need an external 5V supply to power its digital circuits. The 5V power supply can be brought in either from the TB1 terminal block or from the JMACH1 connector.

DAC Outputs Power Supply

0.3A @ +12 to +15V (4.5W)

0.25A @ -12 to -15V (3.8W)

(Eight-channel configuration)

- The host computer provides the ± 12 Volts power supply in the case PMAC is installed in the PC/104 bus. With the board stack into the bus, it will pull ± 12 V power from the bus automatically and it cannot be disconnected. In this case, there must be no external ± 12 V supply, or the two supplies will fight each other, possibly causing damage. This voltage could be measured on the TB1 terminal block.
- In a stand-alone configuration, when PMAC is not plugged in a computer bus, it will need an external ± 12 V supply only when the digital-to-analog converter (DAC) outputs are used. The ± 12 V lines from the supply, including the ground reference, can be brought in either from the TB1 terminal block or from the JMACH1 connector.

Flags Power Supply

Each channel of PMAC has five dedicated digital inputs on the machine connector: PLIMn, MLIMn (overtravel limits), HOMEn (home flag), FAULTn (amplifier fault), and USERn. A power supply from 5 to 24V must be used to power the circuits related to these inputs. This power supply can be the same used to power PMAC and can be connected from the TB1 terminal block or the JMACH1 connector.

Overtravel Limits and Home Switches

When assigned for the dedicated uses, these signals provide important safety and accuracy functions. PLIMn and MLIMn are direction-sensitive over-travel limits that must conduct current to permit motion in that direction. If no over-travel switches will be connected to a particular motor, this feature must be disabled in the software setup through the PMAC Ix25 variable.

Types of Overtravel Limits

PMAC expects a closed-to-ground connection for the limits to not be considered on fault. This arrangement provides a failsafe condition. Usually, a passive normally close switch is used. If a proximity switch is needed instead, use a 5 to 24V normally closed to ground NPN sinking type sensor.

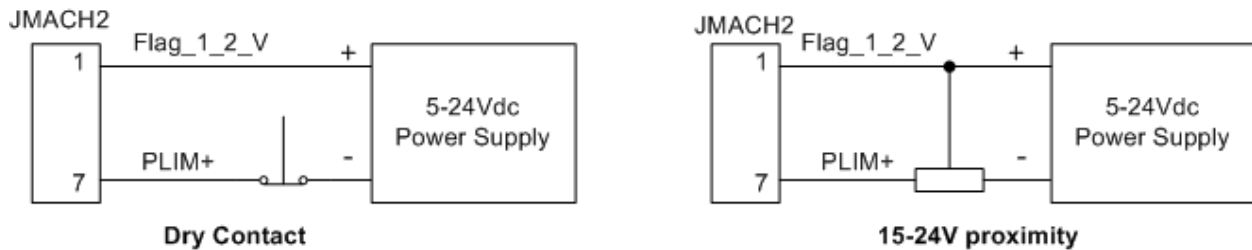

Home Switches

While normally closed-to-ground switches are required for the overtravel limits inputs, the home switches could be either normally close or normally open types. The polarity is determined by the home sequence setup, through the I-variables I9n2. However, for the following reasons, the same type of switches used for over-travel limits are recommended:

- Normally closed switches are proven to have greater electrical noise rejection than normally open types.
- Using the same type of switches for every input flag simplifies maintenance stock and replacements.

Motor Signals Connections

Incremental Encoder Connection

Each JMACH1 connector provides two +5V outputs and two logic grounds for powering encoders and other devices. The +5V outputs are on pins 1 and 2; the grounds are on pins 3 and 4. The encoder signal pins are grouped by number: all those numbered 1 (CHA1+, CHA1-, CHB1+, CHC1+, etc.) belong to encoder #1. The encoder number does not have to match the motor number, but usually does. Connect the A and B (quadrature) encoder channels to the appropriate terminal block pins. For encoder 1, the CHA1+ is pin 5 and CHB1+ is pin 9. If there is a single-ended signal, leave the complementary signal pins floating – do not ground them. However, if single-ended encoders are used, check the settings of the resistor packs (see the Hardware Setup section for details). For a differential encoder, connect the complementary signal lines – CHA1- is pin 7, and CHB1- is pin 11. The third channel (index pulse) is optional; for encoder 1, CHC1+ is pin 13, and CHC1- is pin 15.

Example: differential quadrature encoder connected to channel #1:



DAC Output Signals

If PMAC is not performing the commutation for the motor, only one analog output channel is required to command the motor. This output channel can be either single-ended or differential, depending on what the amplifier is expecting. For a single-ended command using PMAC channel 1, connect DAC1+ (pin 29) to the command input on the amplifier. Connect the amplifier's command signal return line to PMAC's GND line (pin 48). In this setup, leave the DAC1- pin floating; do not ground it.

For a differential command using PMAC channel 1, connect DAC1 (pin 29) to the plus-command input on the amplifier. Connect DAC1- (pin 31) to the minus-command input on the amplifier. PMAC's GND should still be connected to the amplifier common.

To limit the range of each signal to $\pm 5V$, use parameter Ix69. Any analog output not used for dedicated servo purposes may be utilized as a general-purpose analog output. Usually this is done by defining an M-variable to the digital-to-analog-converter register (suggested M-variable definitions M102, M202, etc.), then writing values to the M-variable. The analog outputs are intended to drive high-impedance inputs with no significant current draw. The 220Ω output resistors will keep the current draw lower than 50 mA in all cases and prevent damage to the output circuitry, but any current draw above 10 mA can result in noticeable signal distortion.

Example:

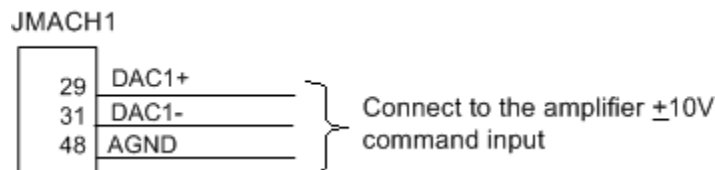

Pulse and Direction (Stepper) Drivers

The channels provided by the PMAC2A PC/104 board or the Acc-1P board can output pulse and direction signals for controlling stepper drivers or hybrid amplifiers. These signals are at TTL levels.

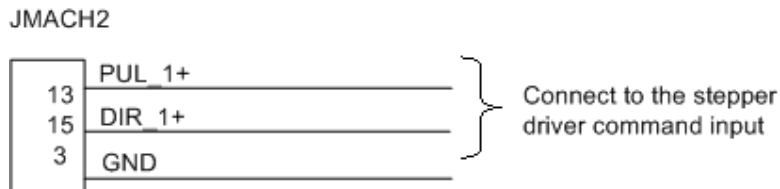

Amplifier Enable Signal (AENAx/DIRn)

Most amplifiers have an enable/disable input that permits complete shutdown of the amplifier regardless of the voltage of the command signal. PMAC's AENA line is meant for this purpose. AENA1- is pin 33. This signal is an open-collector output and an external 3.3 k Ω pull-up resistor can be used if necessary.

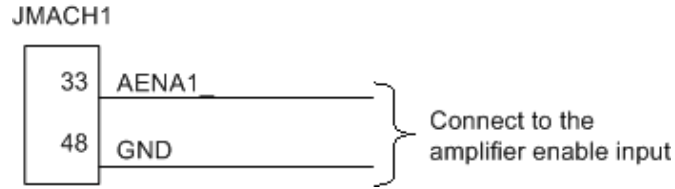

Amplifier Fault Signal (FAULT-)

This input can take a signal from the amplifier so PMAC knows when the amplifier is having problems, and can shut down action. The polarity is programmable with I-variable Ix25 (I125 for motor 1) and the return signal is ground (GND). FAULT1- is pin 35. With the default setup, this signal must actively be pulled low for a fault condition. In this setup, if nothing is wired into this input, PMAC will consider the motor not to be in a fault condition.

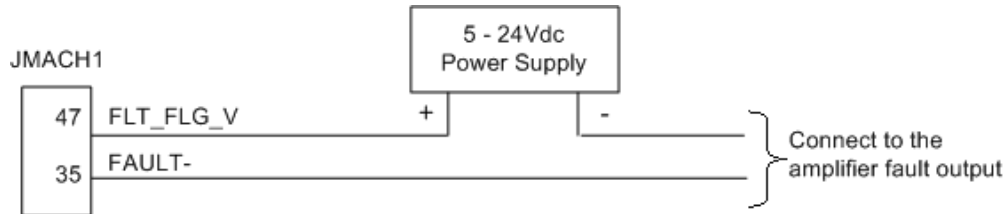

Acc-1P General-Purpose Digital Inputs and Outputs (J7 Port)

Acc-1P J7 connector provides eight general-purpose digital inputs and eight general-purpose digital outputs. Each input and each output has its own corresponding ground pin in the opposite row. The 34-pin connector was designed for easy interface to OPTO-22 or equivalent optically isolated I/O modules. Delta Tau's Acc-21F is a six-foot cable for this purpose. Characteristics of the JOPTO port on the PMAC:

- 16 I/O points. 100 mA per channel, up to 24V
- Hardware selectable between sinking and sourcing in groups of 8; default is all sinking (inputs can be changed simply by moving a jumper; sourcing outputs must be special-ordered or field-configured)
- Eight inputs, and eight outputs only; no changes. Parallel (fast) communications to PMAC CPU
- Not opto-isolated; easily connected to Opto-22 (PB16) or similar modules through Acc-21F cable

Jumper E7 on the Acc-1P board controls the configuration of the eight inputs. If it connects pins 1 and 2 (the default setting), the inputs are biased to +5V for the OFF state, and they must be pulled low for the ON state. If E7 connects pins 2 and 3, the inputs are biased to ground for the OFF state, and must be pulled high for the ON state. In either case, a high voltage is interpreted as a 0 by the PMAC software, and a low voltage is interpreted as a 1.

PMAC is shipped standard with a ULN2803A sinking (open-collector) output IC for the eight outputs. These outputs can sink up to 100 mA and have an internal 3.3 kΩ pull-up resistor to go high (RP18). Do not connect these outputs directly to the supply voltage, or damage to the PMAC will result from excessive current draw. The user can provide a high-side voltage (+5 to +24V) into Pin 33 of the J7 connector, and allow this to pull up the outputs by connecting pins 1 and 2 of Jumper E1. Jumper E2 must also connect pins 1 and 2 for a ULN2803A sinking output.

It is possible for these outputs to be sourcing drivers by substituting a UDN2981A IC for the ULN2803A. This U7 IC is socketed, and so may easily be replaced. Usually the U7 IC is offset by two pins on its socket, and so pins 1 and 2 usually remain open.

WARNING

Having Jumpers E1 and E2 set wrong can damage the IC. The +V output on this connector has a 2A fuse, F1, for excessive current protection.

For this driver, the internal resistor packs pull-down instead. With a UDN2981A driver IC, Jumper E1 must connect pins 2 and 3, and Jumper E2 must connect pins 2 and 3.

Example: Standard configuration using the ULN2803A sinking (open-collector) output IC.

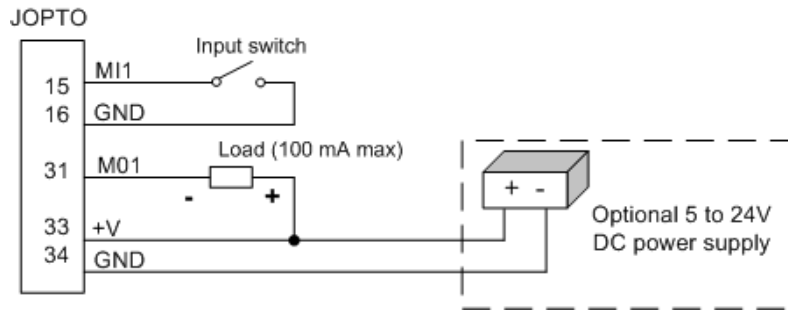

Further software settings are required to configure this port. See the Software Setup section for details.

Acc-2P General-Purpose Digital Inputs and Outputs (JOPT Port)

Acc-2P JOPT connector provides sixteen lines of general-purpose I/O. In contrast with the Acc-1P J7 connector, the lines on the Acc-2P JOPT connector are limited to TTL levels and are usually used with external I/O modules. Each I/O line has its own corresponding ground pin in the opposite row. The 34-pin connector was designed for easy interface to OPTO-22 or equivalent optically isolated I/O modules. Delta Tau's Acc-21F is a six-foot cable for this purpose.

Jumpers E9 and E10 on the Acc-2P board select the I/O lines direction of the JOPT connector. This allows configuring this port as all inputs, all outputs or half inputs and half outputs. Further software settings are required to configure this port. See the Software Setup section for details on this.

Acc-1P Thumbwheel Multiplexer Port (J2 Port)

The Thumbwheel Multiplexer Port, or Multiplexer Port, on the J2 connector has eight input lines and eight output lines. The output lines can be used to multiplex large numbers of inputs and outputs on the port, and Delta Tau provides accessory boards and software structures (special M-variable definitions) to capitalize on this feature. Up to 32 of the multiplexed I/O boards may be daisy-chained on the port, in any combination. Either the Acc-1P or the Acc-2P boards, but not both, can use this connector as a multiplexing port. This is selected by jumper E6 on the Acc-1P board and jumper E5 on the Acc-2P board.

Alternatively, the inputs and outputs on this port may be used as discrete, non-multiplexed I/O. In this case, these I/O lines can be accessed through M-variables. See the Software Setup section for details on this.

Acc-2P Thumbwheel Multiplexer Port (JTHW Port)

The Thumbwheel Multiplexer Port, or Multiplexer Port, on the JTHW connector has sixteen lines. These lines can be used to multiplex large numbers of inputs and outputs on the port, and Delta Tau provides accessory boards and software structures (special M-variable definitions) to capitalize on this feature. Up to 32 of the multiplexed I/O boards may be daisy-chained on the port, in any combination. Either the Acc-1P or the Acc-2P boards, but not both, can use this connector as a multiplexing port. This is selected by jumper E6 on the Acc-1P board and jumper E5 on the Acc-2P board.

Alternatively, the inputs and outputs on this port may be used as discrete, non-multiplexed I/O. In this case, these I/O lines can be accessed through M-variables. See the Software Setup section for details on this.

When used as non-multiplexed I/O, jumpers E7 and E8 on the Acc-2P board select the I/O lines direction of the JTHW connector. This allows configuring this port as all inputs, all outputs or half inputs and half outputs. If E7 is removed or E8 is installed then the multiplexing feature of the JTHW port cannot be used.

Acc-1P or Acc-2P Handwheel Port (JHW / PD Port)

This port provides an extra encoder input or a set of pulse and direction outputs. Jumpers E3 and E4 on either the Acc-1P or Acc-2P boards select the function of this connector between encoder input or pulse and direction outputs. The handwheel encoder input can be linked to a servomotor for manual displacement or used by a motor as a secondary encoder for dual-feedback applications. There is no C index channel input on the handwheel encoder port. The pulse and direction outputs can be used, for example, to control an external laser device but not a stepper driver/motor, since this would require more than eight axes of motion control.

Optional Analog Inputs

The optional analog-to-digital converter inputs are ordered either through Option-12 on the baseboard or Option-2 on the axes expansion board. Each option provides two 12-bit analog inputs with a $\pm 10Vdc$ range.

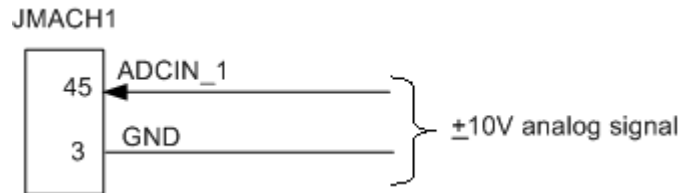

Compare Equal Outputs

The compare-equals (EQU) outputs have a dedicated use of providing a signal edge when an encoder position reaches a pre-loaded value. This is very useful for scanning and measurement applications. Instructions for use of these outputs are covered in detail in the PMAC2 User Manual.

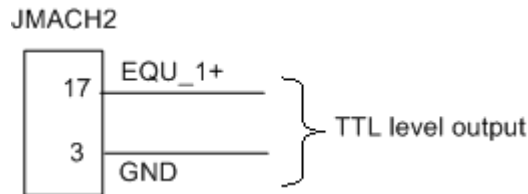

Serial Port (JRS232 Port)

For serial communications, use a serial cable to connect your PC's COM port to the J8 serial port connector present on the PMAC2A PC/104 baseboard. Delta Tau provides the Acc-3L cable for this purpose that connects the PMAC to a DB-9 connector. Standard DB-9-to-DB-25 or DB-25-to-DB-9 adapters may be needed for your particular setup. If a cable needs to be made, the easiest approach is to use a flat cable prepared with flat-cable type connectors as indicated in the following diagram:

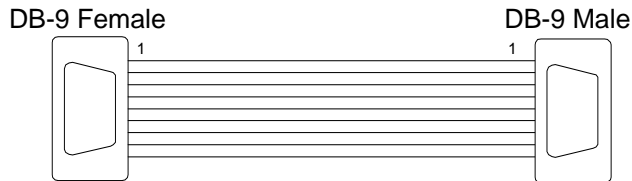

PMAC (DB-9S)	PC (DB-9)
1 (No connect)	1 (No connect)
2 (TXD/)	2 (RXD)
3 (RXD/)	3 (TXD)
4 (DSR)	4 (DTR)
5 (Gnd)	5 (Gnd)
6 (DTR)	6 (DSR)
7 (CTS)	7 (RTS)
8 (RTS)	8 (CTS)
9 (No connect)	9 (No connect)

Acc-2P Ethernet RJ45 Connector (J10 Port)

This connector is used for Ethernet communications from the Acc-2P to a PC, and it is provided when Acc-2P Option 1B is ordered. The PC must have a card dedicated solely to the PMAC network. The appropriate Category 5 10/100-Base T network cable that mates to this connector can be readily purchased from any local computer store. The type of network cable to purchase depends on the configuration to the host PC.

When making a direct connection to a Host communication Ethernet card in a PC a cat 5 networking crossover cable must be used. A standard cat 5 straight through networking cable cannot be used in this scenario. When using a connection to a network hub or switch, the standard cat 5 straight through networking cable must be used, and not a crossover cable.

Performance can be degraded seriously by the use of a hub or switch. Network hubs or the more intelligent network switches have processors inside them, which can add delays of at least 15msec to the PMAC communications.

Acc-2P USB Connector (J1 Port)

This connector is to be used in conjunction with USB A-B cable, which can be purchased from any local computer store, and it is provided when Acc-2P Option 1A is ordered. The A connector is connected to a PC or Hub device; the B connector plugs into the Acc-2P J1 port.

Machine Connections Example: Using Analog $\pm 10V$ Amplifier

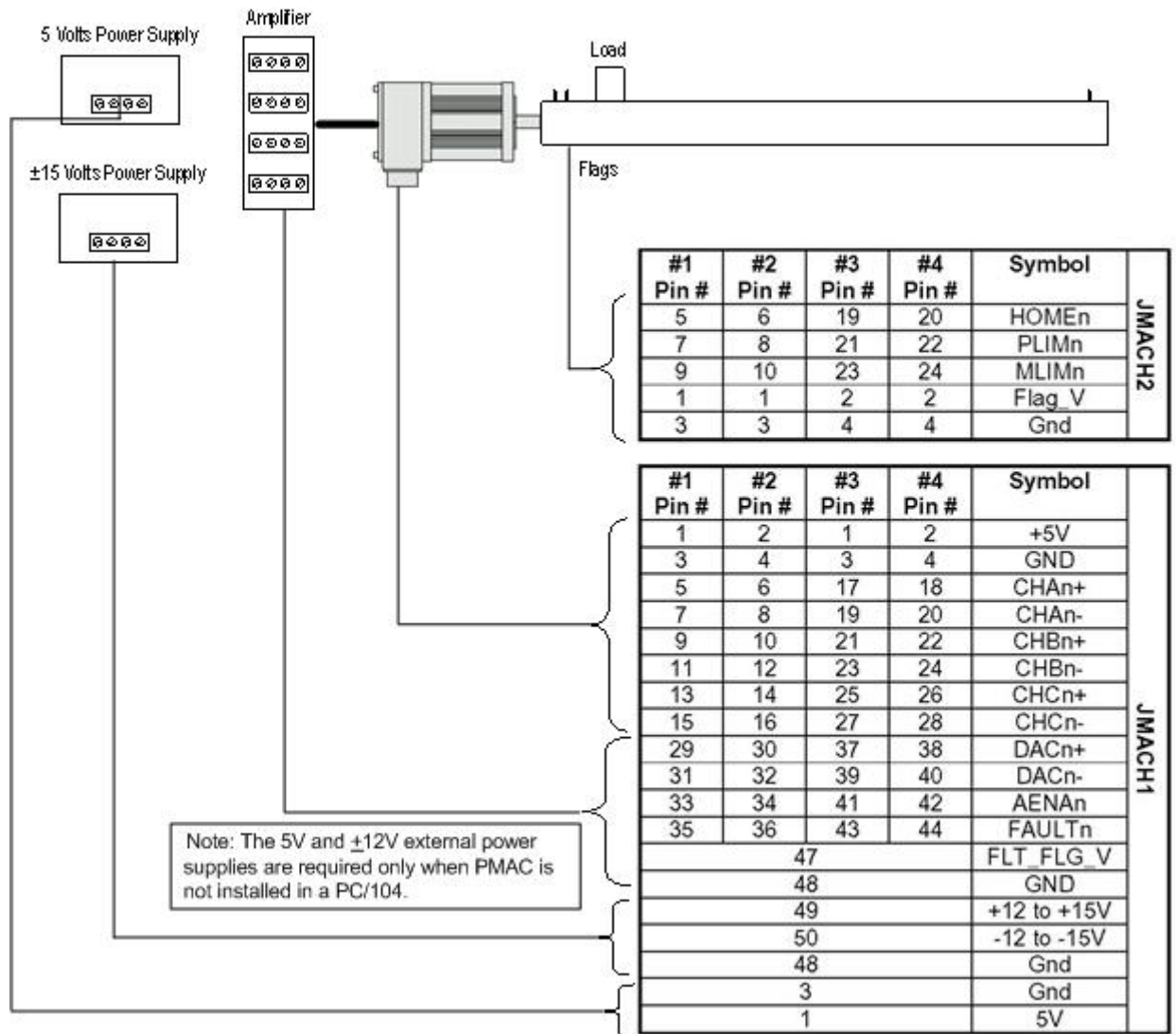

Machine Connections Example: Using Pulse and Direction Drivers

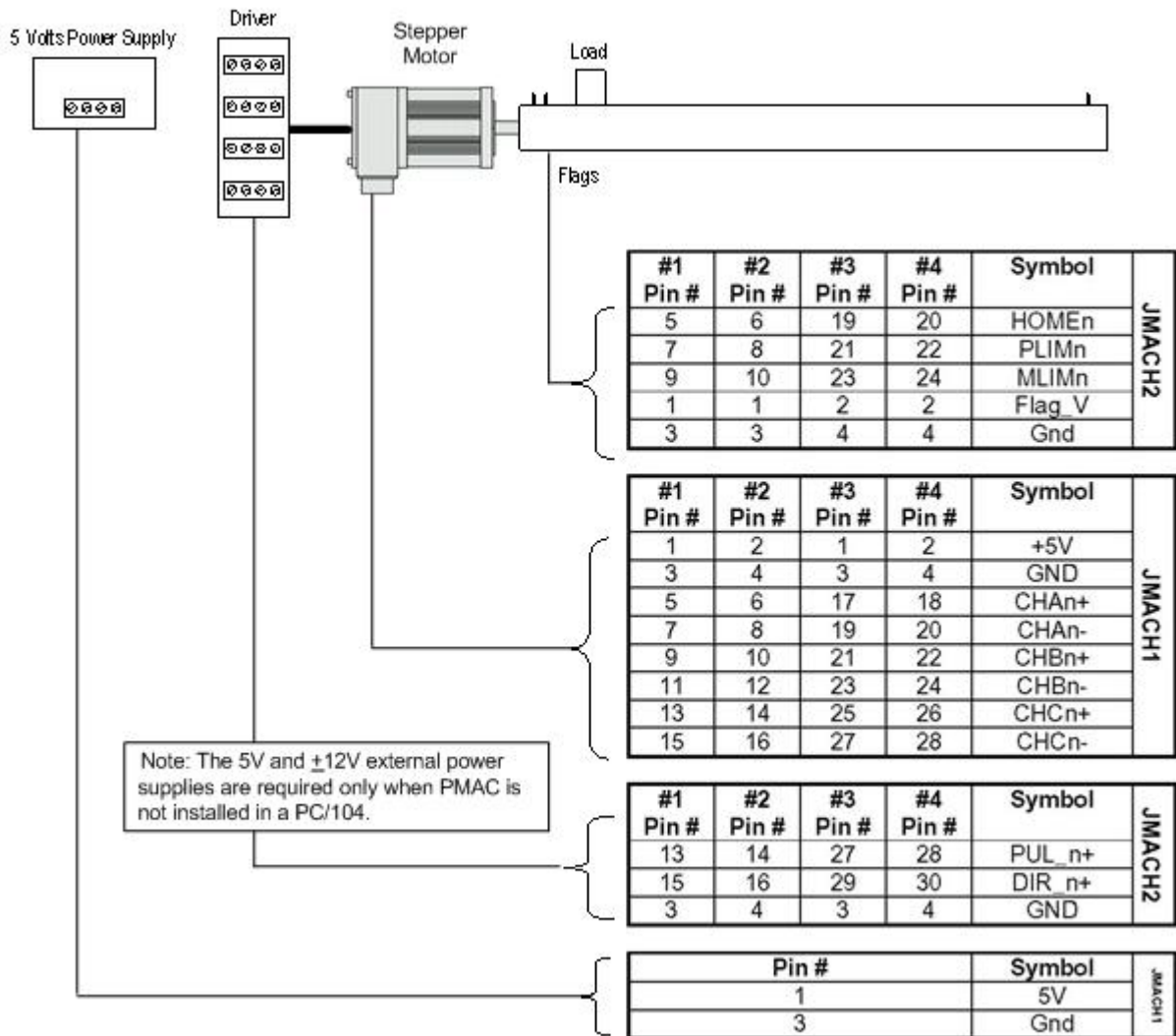

SOFTWARE SETUP

Note:

The PMAC2A PC/104 requires the use of V1.17 or newer firmware. There are few differences between the previous V1.16H firmware and the V1.17 firmware other than the addition of internal support for the Flex CPU design.

Communications

Delta Tau provides software tools that allow communicating with of the PMAC2A PC/104 board by either its standard RS-232 port or the optional USB or Ethernet ports. PEWIN is the most important in the series of software accessories, and it allows configuring and programming the PMAC for any particular application.

PMAC I-Variables

PMAC has a large set of Initialization parameters (I-variables) that determine the "personality" of the card for a specific application. Many of these are used to configure a motor properly. Once set up, these variables may be stored in non-volatile EAROM memory (using the **SAVE** command) so the card is always configured properly (PMAC loads the EAROM I-variable values into RAM on power-up).

The programming features and configuration variables for the PMAC2A PC/104 are described fully in the PMAC2 User and Software manuals.

Operational Frequency and Baud Rate Setup

Note:

Older PMAC boards required a start-up PLC for setting the operational frequency at 80 MHz. That method is not compatible with the PMAC2A PC/104 board and will shutdown the board when used.

The operational frequency of the CPU can be set in software by the variable I46. If this variable is set to 0, PMAC firmware looks at the jumpers E2 and E4 to set the operational frequency for 40, 60, and 80 MHz operation. If I46 is set to a value greater than 0, the operational frequency is set to $10\text{MHz} * (I46 + 1)$, regardless of the jumper setting. If the desired operational frequency is higher than the maximum rated frequency for that CPU, the operational frequency will be reduced to the rated maximum. It is always possible to operate the Flex CPU board at a frequency below its rated maximum. I46 is used only at power-up/reset, so to change the operational frequency, set a new value of I46, issue a **SAVE** command to store this value in non-volatile flash memory, then issue a **\$\$\$** command to reset the controller.

To determine the frequency at which the CPU is actually operating, issue the **TYPE** command to the PMAC. The PMAC will respond with five data items, the last of which is **CLK Xn**, where *n* is the multiplication factor from the 20 MHz crystal frequency (not 10 MHz). *n* should be equivalent to $(I46+1)/2$ if I46 is not requesting a frequency greater than the maximum rated for that CPU board. *n* will be 2 for 40 MHz operation, 4 for 80 MHz operation, and 8 for 160 MHz operation.

If the CPU's operational frequency has been determined by (a non-zero setting of) I46, the serial communications baud rate is determined at power-up/reset by variable I54 alone according to the following table:

I54	Baud Rate	I54	Baud Rate
0	600	8	9600
1	900	9	14,400
2	1200	10	19,200
3	1800	11	28,800
4	2400	12	38,400
5	3600	13	57,600
6	4800	14	76,800
7	7200	15	115,200

For a saved value of 0 for I46, the serial baud rate is determined by the combination of I54 and the CPU frequency as shown in the following table.

I54	Baud Rate for 40 MHz CPU	Baud Rate for 60 MHz CPU	Baud Rate for 80 MHz CPU
0	600	Disabled	1200
1	900* (-0.05%)	900	1800* (-0.1%)
2	1200	1200	2400
3	1800* (-0.1%)	1800	3600* (-0.19%)
4	2400	2400	4800
5	3600* (-0.19%)	3600	7200* (-0.38%)
6	4800	4800	9600
7	7200* (-0.38%)	7200	14,400* (-0.75%)
8	9600	9600	19,200
9	14,400* (-0.75%)	14,400	28,800* (-1.5%)
10	19,200	19,200	38,400
11	28,800* (-1.5%)	28,800	57,600* (-3.0%)
12	38,400	38,400	76,800
13	57,600* (-3.0%)	57,600	115,200* (-6.0%)
14	76,800	76,800	153,600
15	Disabled	115,200	Disabled

* Not an exact baud rate

Filtered DAC Outputs Configuration

The following I-variables must be set properly to use the digital-to-analog (filtered DAC) outputs:

```

I900 = 1001 ; PWM frequency 29.4kHz, PWM 1-4
I901 = 2 ; Phase Clock 19.6kHz
I902 = 3 ; Servo frequency 4.9kHz
I903 = 1746 ; ADC frequency
I906 = 1001 ; PWM frequency 29.4kHz, PWM 5-8
I907 = 1746 ; ADC frequency
I9n6 = 0 ; Output mode: PWM
Ix69 = 1001 ; DAC limit 10Vdc
I10 = 1710933 ; Servo interrupt time
    
```

n = channel number from 1 to 8

x = motor number from 1 to 8

Using Flag I/O as General-Purpose I/O

Either the user flags or other not assigned axes flag on the base board can be used as general-purpose I/O for up to 20 inputs and 4 outputs at 5-24Vdc levels. The indicated suggested M-variables definitions, which are defined in the PMAC2 Software reference, allows accessing each particular line according to the following table:

Flag	Type	Channel Number			
		#1	#2	#3	#4
HOME	5-24 VDC Input	M120	M220	M320	M420
PLIM	5-24 VDC Input	M121	M221	M321	M421
MLIM	5-24 VDC Input	M122	M222	M322	M422
USER	5-24 VDC Input	M115	M215	M315	M415
AENA	5-24 VDC Output	M114	M214	M314	M414

Note:

When using these lines as regular I/O points the appropriate setting of the Ix25 variable must be used to enable or disable the safety flags feature.

General-Purpose Digital Inputs and Outputs

If one Acc-1P is present on the PMAC2A PC/104 stack configuration then its jumpers E5 and E6 should be set at the default position 1-2. In this case, the lines on its J7 general-purpose I/O connector will be mapped into PMAC's address space in register Y:\$C080. Jumpers E5 and E6 should be configured on position 2-3 only when two Acc-1Ps are used. In this case, the I/O lines can be accessed at address Y:\$C0C0.

If no Acc-1P is present on the PMAC2A PC/104 stack configuration, and only Acc-2P is used, then jumper E5 on the Acc-2P board should connect pins 1 and 2. In this case the lines on its JOPT general-purpose I/O connector will be mapped into PMAC's address space in register Y:\$C080.

If both Acc-1P and Acc-2P are used, then jumper E5 on the Acc-2P board should connect pins 2 and 3 and its I/O lines can be accessed at address Y:\$C0C0.

Typically, these I/O lines are accessed individually with M-variables. Following is a suggested set of M-variable definitions to use these data lines.

Acc-1P with Jumper E6 on Position 1-2

```

M0->Y:$C080,0           ; Digital Output M00
M1->Y:$C080,1           ; Digital Output M01
M2->Y:$C080,2           ; Digital Output M02
M3->Y:$C080,3           ; Digital Output M03
M4->Y:$C080,4           ; Digital Output M04
M5->Y:$C080,5           ; Digital Output M05
M6->Y:$C080,6           ; Digital Output M06
M7->Y:$C080,7           ; Digital Output M07
M8->Y:$C080,8           ; Digital Input MI0
M9->Y:$C080,9           ; Digital Input MI1
M10->Y:$C080,10          ; Digital Input MI2
M11->Y:$C080,11          ; Digital Input MI3
M12->Y:$C080,12          ; Digital Input MI4
M13->Y:$C080,13          ; Digital Input MI5
M14->Y:$C080,14          ; Digital Input MI6
M15->Y:$C080,15          ; Digital Input MI7
M32->X:$C080,0,8         ; Direction Control (1=output, 0 = input)
M34->X:$C080,8,8         ; Direction Control (1=output, 0 = input)
M40->X:$C084,0,24        ; Inversion control (0 = 0V, 1 = 5V)
M42->Y:$C084,0,24        ; J7 port data type control (1 = I/O)
    
```

In order to properly setup the digital outputs an initialization PLC must be written scanning through once on power-up/reset, then disabling itself:

```

OPEN PLC1 CLEAR
M32=$FF           ;BITS 0-8 are assigned as output
M34=$0           ;BITS 9-16 are assigned as input
M40=$FF00        ;Define inputs and outputs voltages
M42=$FFFF        ;All lines are I/O type
DIS PLC1         ;Disable PLC1 (scanning through once on
                ;power-up/reset)

CLOSE
    
```

Note:

After loading this program, set I5=2 or 3 and ENABLE PLC 1.

Acc-2P with Jumper E5 in Position 2-3

```

M0->Y:$C0C0,0    ; Digital Output M00
M1->Y:$C0C0,1    ; Digital Output M01
M2->Y:$C0C0,2    ; Digital Output M02
M3->Y:$C0C0,3    ; Digital Output M03
M4->Y:$C0C0,4    ; Digital Output M04
M5->Y:$C0C0,5    ; Digital Output M05
M6->Y:$C0C0,6    ; Digital Output M06
M7->Y:$C0C0,7    ; Digital Output M07
M8->Y:$C0C0,8    ; Digital Input MI0
M9->Y:$C0C0,9    ; Digital Input MI1
M10->Y:$C0C0,10  ; Digital Input MI2
M11->Y:$C0C0,11  ; Digital Input MI3
M12->Y:$C0C0,12  ; Digital Input MI4
M13->Y:$C0C0,13  ; Digital Input MI5
M14->Y:$C0C0,14  ; Digital Input MI6
M15->Y:$C0C0,15  ; Digital Input MI7
M32->X:$C0C0,0,8 ; Direction Control (1=output, 0 = input)
M34->X:$C0C0,8,8 ; Direction Control (1=output, 0 = input)
M40->X:$C0C4,0,24 ; Inversion control (0 = 0V, 1 = 5V)
M42->Y:$C0C4,0,24 ; JI/O port data type control (1 = I/O)
    
```

In order to properly setup the digital outputs, an initialization PLC must be written scanning through once on power-up/reset, and then disabling itself:

```

OPEN PLC1 CLEAR
M32=$FF           ;BITS 0-8 are assigned as output
M34=$0           ;BITS 9-16 are assigned as input
M40=$FFFF        ;Define inputs and outputs voltages
M42=$FFFF        ;All lines are I/O type
DIS PLC1         ;Disable PLC1 (scanning through once on
                ;power-up/reset)

CLOSE
    
```

Note:

After loading this program, set I5=2 or 3 and ENABLE PLC 1.

Thumbwheel Port Digital Inputs and Outputs

The inputs and outputs on the thumbwheel multiplexer port of either the Acc-1P or the Acc-2P boards may be used as discrete, non-multiplexed I/O. In this case, these I/O lines can be accessed through M-variables that are defined according to the setup of the address selection jumpers. Jumper E6 on the Acc-1P or E5 on the Acc-2P determine which set of the following M-variables are used:

Acc-1P with Jumper E6 in Position 1-2

M40->Y:\$C082,8,1	; SEL0 Output
M41->Y:\$C082,9,1	; SEL1 Output
M42->Y:\$C082,10,1	; SEL2 Output
M43->Y:\$C082,11,1	; SEL3 Output
M44->Y:\$C082,12,1	; SEL4 Output
M45->Y:\$C082,13,1	; SEL5 Output
M46->Y:\$C082,14,1	; SEL6 Output
M47->Y:\$C082,15,1	; SEL7 Output
M48->Y:\$C082,8,8,U	; SEL0-7 Outputs treated as a byte
M50->Y:\$C082,0,1	; DAT0 Input
M51->Y:\$C082,1,1	; DAT1 Input
M52->Y:\$C082,2,1	; DAT2 Input
M53->Y:\$C082,3,1	; DAT3 Input
M54->Y:\$C082,4,1	; DAT4 Input
M55->Y:\$C082,5,1	; DAT5 Input
M56->Y:\$C082,6,1	; DAT6 Input
M57->Y:\$C082,7,1	; DAT7 Input
M58->Y:\$C082,0,8,U	; DAT0-7 Inputs treated as a byte

Acc-2P with Jumper E5 in Position 2-3

M40->Y:\$C0C2,8,1	; SEL0 I/O Line
M41->Y:\$C0C2,9,1	; SEL1 I/O Line
M42->Y:\$C0C2,10,1	; SEL2 I/O Line
M43->Y:\$C0C2,11,1	; SEL3 I/O Line
M44->Y:\$C0C2,12,1	; SEL4 I/O Line
M45->Y:\$C0C2,13,1	; SEL5 I/O Line
M46->Y:\$C0C2,14,1	; SEL6 I/O Line
M47->Y:\$C0C2,15,1	; SEL7 I/O Line
M48->Y:\$C0C2,8,8,U	; SEL0-7 I/O Lines treated as a byte
M50->Y:\$C0C2,0,1	; DAT0 I/O Line
M51->Y:\$C0C2,1,1	; DAT1 I/O Line
M52->Y:\$C0C2,2,1	; DAT2 I/O Line
M53->Y:\$C0C2,3,1	; DAT3 I/O Line
M54->Y:\$C0C2,4,1	; DAT4 I/O Line
M55->Y:\$C0C2,5,1	; DAT5 I/O Line
M56->Y:\$C0C2,6,1	; DAT6 I/O Line
M57->Y:\$C0C2,7,1	; DAT7 I/O Line
M58->Y:\$C0C2,0,8,U	; DAT0-7 I/O Lines treated as a byte

Analog Inputs Setup

The optional analog-to-digital converter inputs are ordered either through Option-12 on the baseboard or Option-2 on the axes expansion board. Each option provides two 12-bit analog inputs with a $\pm 10\text{Vdc}$ range. The M-variables associated with these inputs provided a range of values between +2048 and -2048 for the respective $\pm 10\text{Vdc}$ input range. The following is the software procedure to setup and read these ports.

Baseboard Analog Inputs

```
I903 = 1746 ;Set ADC clock frequency at 4.9152 MHz
WX:$C014, $1FFFFFF ;Clock strobe set for bipolar inputs
M105->X:$0710,12,12,S ;ADCIN_1 on JMACH1 connector pin 45
M205->X:$0711,12,12,S ;ADCIN_2 on JMACH1 connector pin 46
```

Acc-1P Analog Inputs

```
I907 = 1746 ;Set ADC clock frequency at 4.9152 MHz
WX:$C034, $1FFFFFF ;Clock strobe set for bipolar inputs
M305->X:$0714,12,12,S ;ADCIN_1 on JMACH1 connector (Acc-1P) pin 45
M405->X:$0715,12,12,S ;ADCIN_2 on JMACH1 connector (Acc-1P) pin 46
```

BASE BOARD HARDWARE REFERENCE SUMMARY

The following information is based on the PMAC2A PC/104 board, part number 603670-100.

Board Dimensions

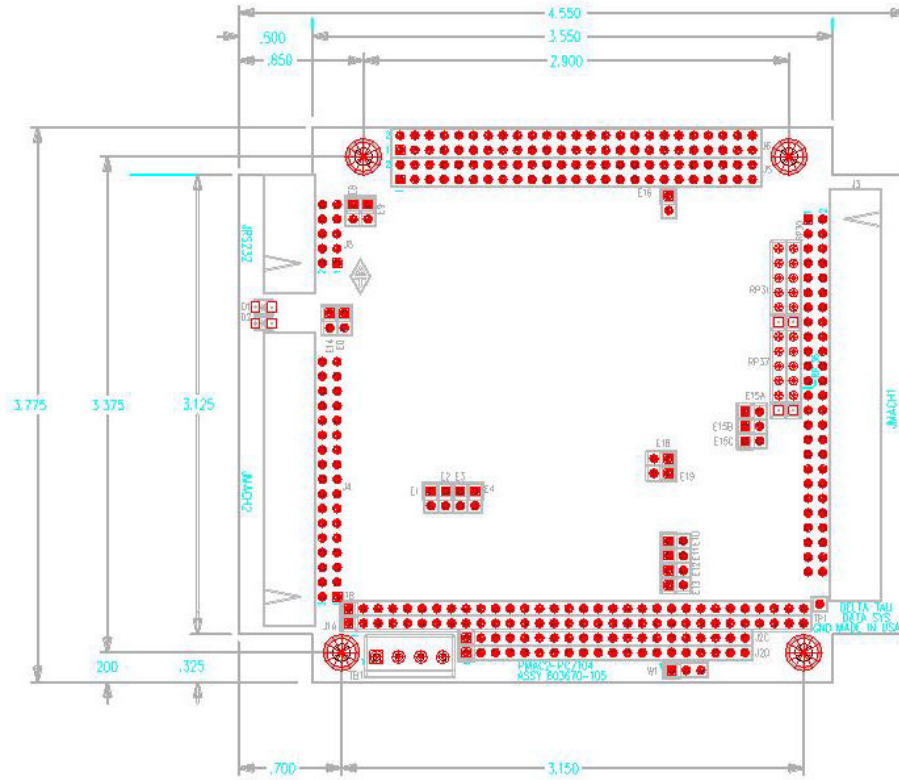

Board Layout

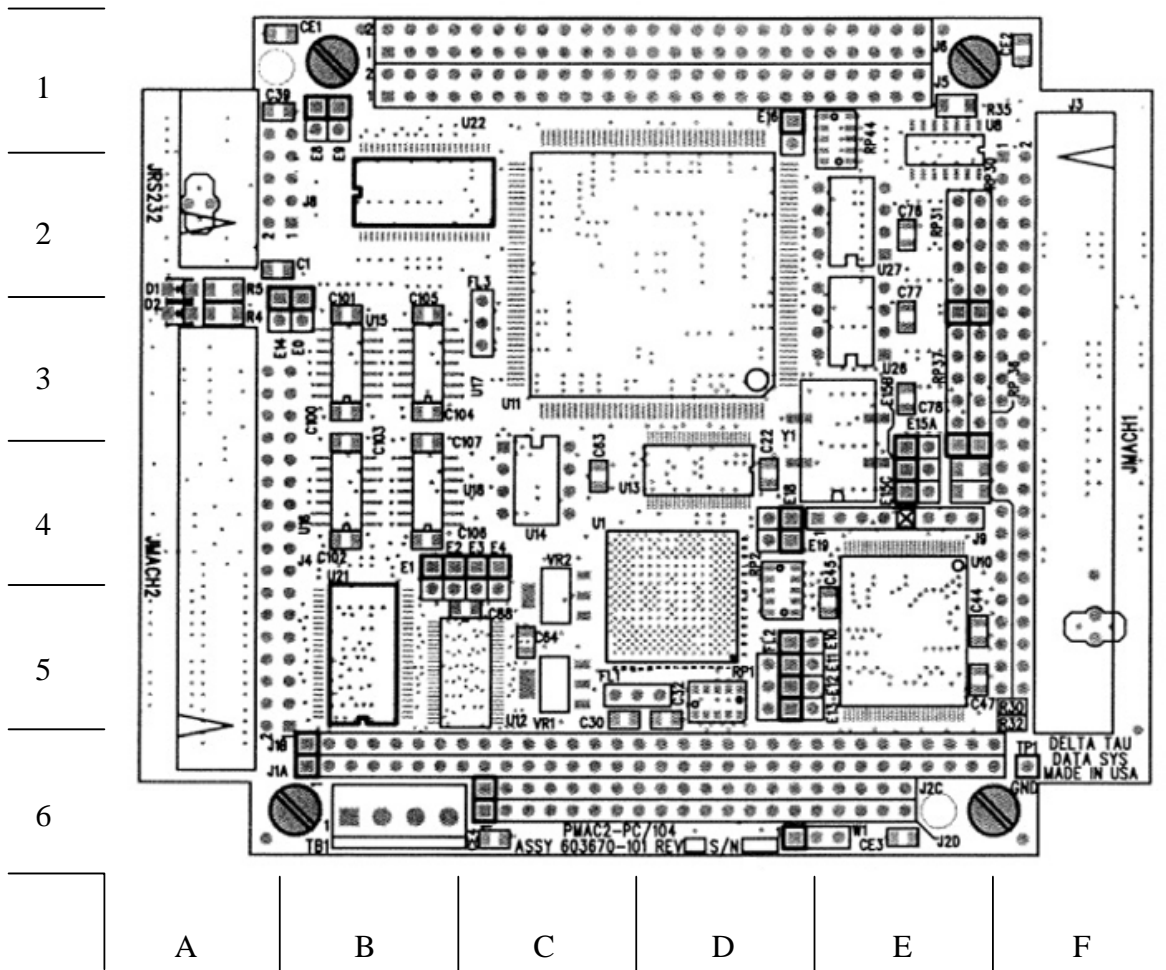

Feature	Location	Feature	Location	Feature	Location
E0	B3	E13	E5	RP30	E2
E1	B4	E14	B3	RP31	E2
E2	B4	E15A	E4	RP36	E3
E3	C4	E15B	E4	RP37	E3
E4	C4	E15C	E4	D1	A2
E8	B1	E16	D1	D2	A3
E9	B1	E18	D4	TB1	B6
E10	E5	E19	D4	JRS232	A2
E11	E5	W1	E6	JMACH1	F3
E12	E5			JMACH2	A4

Connectors and Indicators

J3 - Machine Connector (JMACH1 Port)

The primary machine interface connector is JMACH1, labeled J3 on the PMAC. It contains the pins for four channels of machine I/O: analog outputs, incremental encoder inputs, amplifier fault and enable signals and power-supply connections.

1. 50-pin female flat cable connector T&B Ansley P/N 609-5041
2. Standard flat cable stranded 50-wire T&B Ansley P/N 171-50
3. Phoenix varioface module type FLKM 50 (male pins) P/N 22 81 08 9

J4 - Machine Connector (JMACH2 Port)

This machine interface connector is labeled JMACH2 or J4 on the PMAC. It contains the pins for four channels of machine I/O: end-of-travel input flags, home flag and pulse-and-direction output signals. In addition, the B_WDO output allows monitoring the state of the Watchdog safety feature.

1. 34-pin female flat cable connector T&B Ansley P/N 609-3441
2. Standard flat cable stranded 34-wire T&B Ansley P/N 171-34
3. Phoenix varioface module type FLKM 34 (male pins) P/N 22 81 06 3

J8 - Serial Port (JRS232 Port)

This connector allows communicating with PMAC from a host computer through a RS-232 port. Delta Tau provides the Accessory 3L cable that connects the PMAC to a DB-9 connector.

1. 10-pin female flat cable connector T&B Ansley P/N 609-1041
2. Standard flat cable stranded 10-wire T&B Ansley P/N 171-10

TB1 – Power Supply Terminal Block (JPWR Connector)

In almost in all cases the PMAC2A PC/104 will be powered from the PC/104 bus, when it is installed in a host computer's bus, or from the JMACH1 connector. This terminal block may be used as an alternative power supply connector or to easily measure the voltages applied to the board.

1. 4-pin terminal block, 0.150 pitch

LED Indicators

D1: when this red LED is lit, it indicates that the watchdog timer has tripped and shut down the PMAC.

D2: when this green LED is lit, it indicates that power is applied to the +5V input.

ACC-1P HARDWARE REFERENCE SUMMARY

The following information is based on the Acc-1P board, part number 603671-100.

Board Dimensions

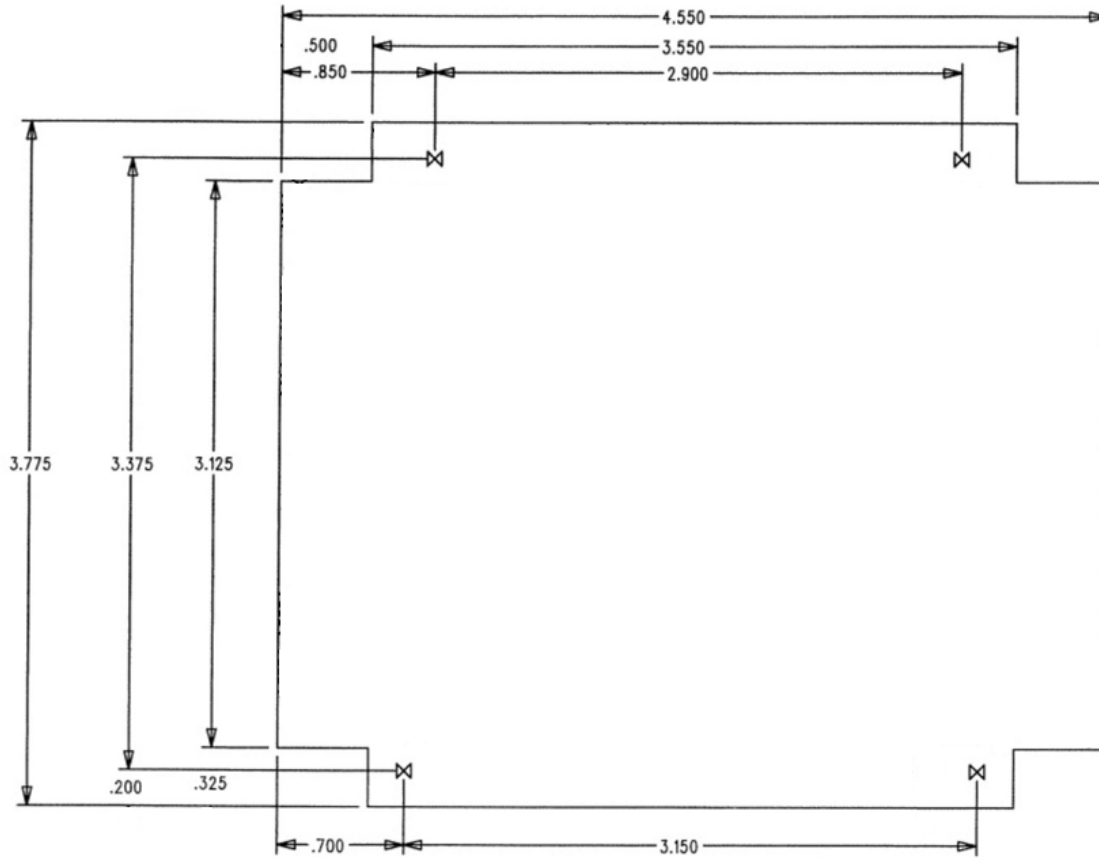

Board Layout

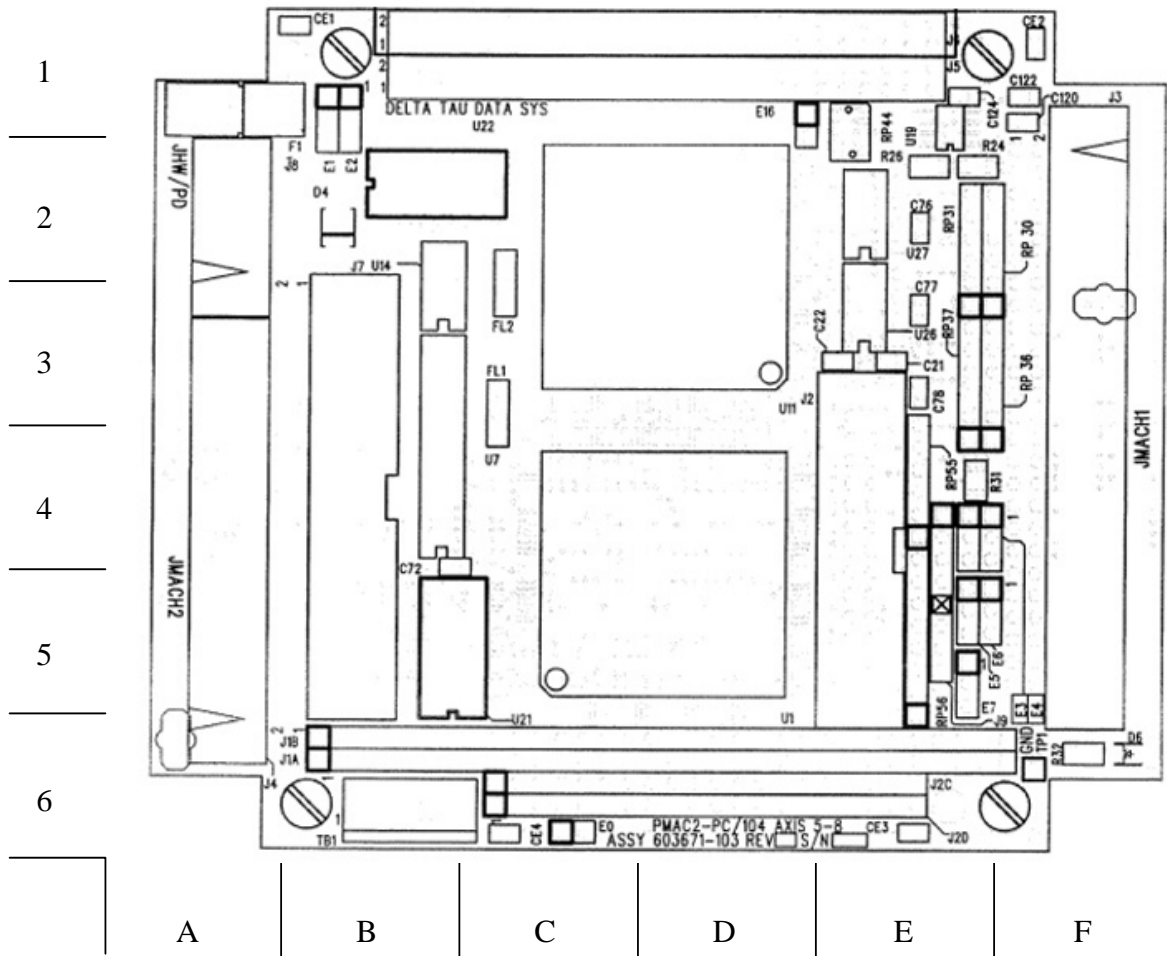

Feature	Location	Feature	Location
E0	C6	RP30	E2
E1	B2	RP31	E2
E2	B2	RP36	E3
E3	E4	RP37	E3
E4	E4	RP55	E4
E5	E5	RP56	E5
E6	E5	TB1	B6
E7	E5	JMACH1	F4
E16	D1	JMACH2	A4
D6	F6	JHW / PD	A2
F1	A1	J7	A3
		J2	E4

Connectors and Indicators

J2 - Thumbwheel Multiplexer Port (JTHW Port)

The Thumbwheel Multiplexer Port, or Multiplexer Port, on the JTHW connector has eight input lines and eight output lines. The output lines can be used to multiplex large numbers of inputs and outputs on the port, and Delta Tau provides accessory boards and software structures (special M-variable definitions) to capitalize on this feature. Up to 32 of the multiplexed I/O boards may be daisy-chained on the port, in any combination.

1. 26-pin female flat cable connector T&B Ansley P/N 609-2641
2. Standard flat cable stranded 26-wire T&B Ansley P/N 171.26
3. Phoenix varioface module type FLKM 26 (male pins) P/N 22 81 05 0

J3 - Machine Connector (JMACH1 Port)

The primary machine interface connector is JMACH1, labeled J3 on the PMAC. It contains the pins for four channels of machine I/O: analog outputs, incremental encoder inputs, amplifier fault and enable signals and power-supply connections.

1. 50-pin female flat cable connector T&B Ansley P/N 609-5041
2. Standard flat cable stranded 50-wire T&B Ansley P/N 171-50
3. Phoenix varioface module type FLKM 50 (male pins) P/N 22 81 08 9

J4 - Machine Connector (JMACH2 Port)

This machine interface connector is labeled JMACH2 or J4 on the PMAC. It contains the pins for four channels of machine I/O: end-of-travel input flags, home flag and pulse-and-direction output signals. In addition, the B_WDO output allows monitoring the state of the Watchdog safety feature.

1. 34-pin female flat cable connector T&B Ansley P/N 609-3441
2. Standard flat cable stranded 34-wire T&B Ansley P/N 171-34
3. Phoenix varioface module type FLKM 34 (male pins) P/N 22 81 06 3

J7 - General-Purpose Digital Inputs and Outputs (JOPT Port)

Acc-1P's JOPT connector provides eight general-purpose digital inputs and eight general-purpose digital outputs. Each input and each output has its own corresponding ground pin in the opposite row. The 34-pin connector was designed for easy interface to OPTO-22 or equivalent optically isolated I/O modules. Delta Tau's Acc-21F is a six-foot cable for this purpose.

1. 34-pin female flat cable connector T&B Ansley P/N 609-3441
2. Standard flat cable stranded 34-wire T&B Ansley P/N 171-34
3. Phoenix varioface module type FLKM 34 (male pins) P/N 22 81 06 3

J8 – Handwheel / Pulse and Direction Port (JHW / PD Port)

This port provides an extra encoder input or a set of pulse and direction outputs, and its function is selectable by jumpers.

1. 10-pin female flat cable connector T&B Ansley P/N 609-1041
2. Standard flat cable stranded 10-wire T&B Ansley P/N 171-10
3. Phoenix varioface module type FLKM 10 (male pins) P/N 22 81 01 8

TB1 – Power Supply Terminal Block (JPWR Connector)

In almost in all cases the PMAC2A PC/104 will be powered from the PC/104 bus when it is installed in a host computer's bus, or from the JMACH1 connector. This terminal block may be used as an alternative power supply connector or to easily measure the voltages applied to the board.

1. 4-pin terminal block, 0.150 pitch

ACC-2P HARDWARE REFERENCE SUMMARY

The following information is based on the Acc-2P board, part number 603672-100.

Board Dimensions

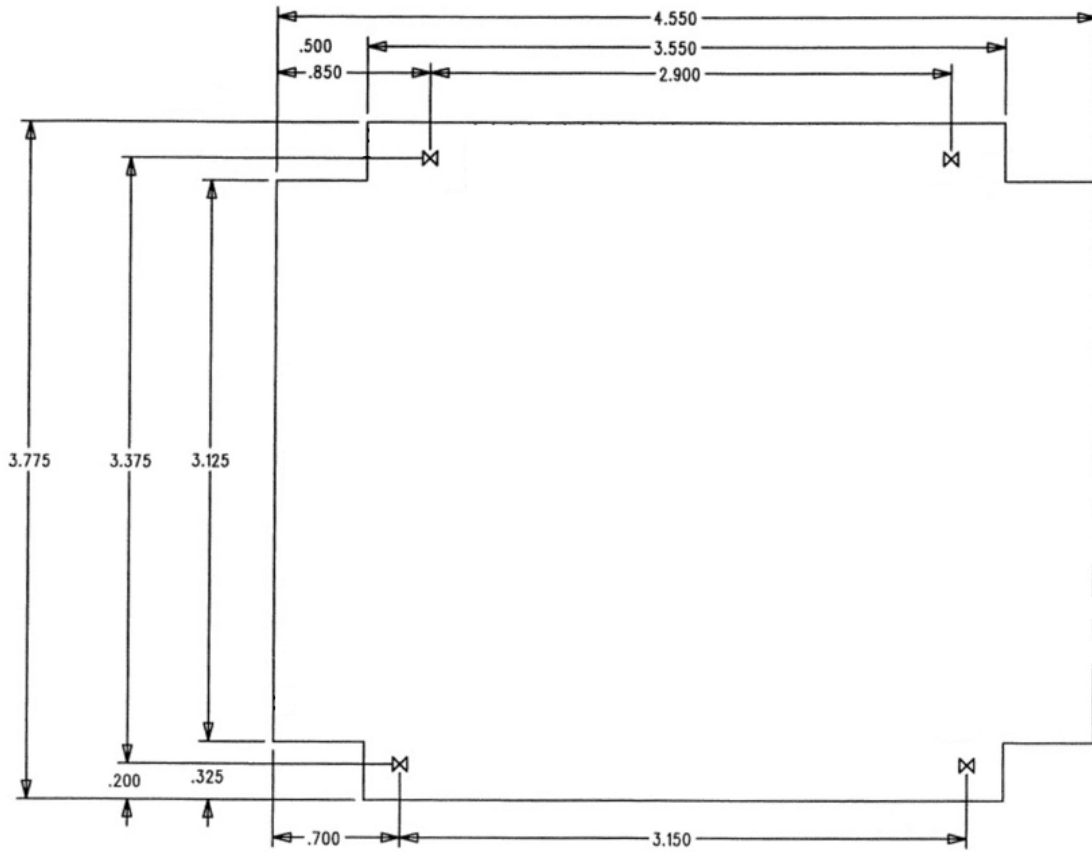

Board Layout

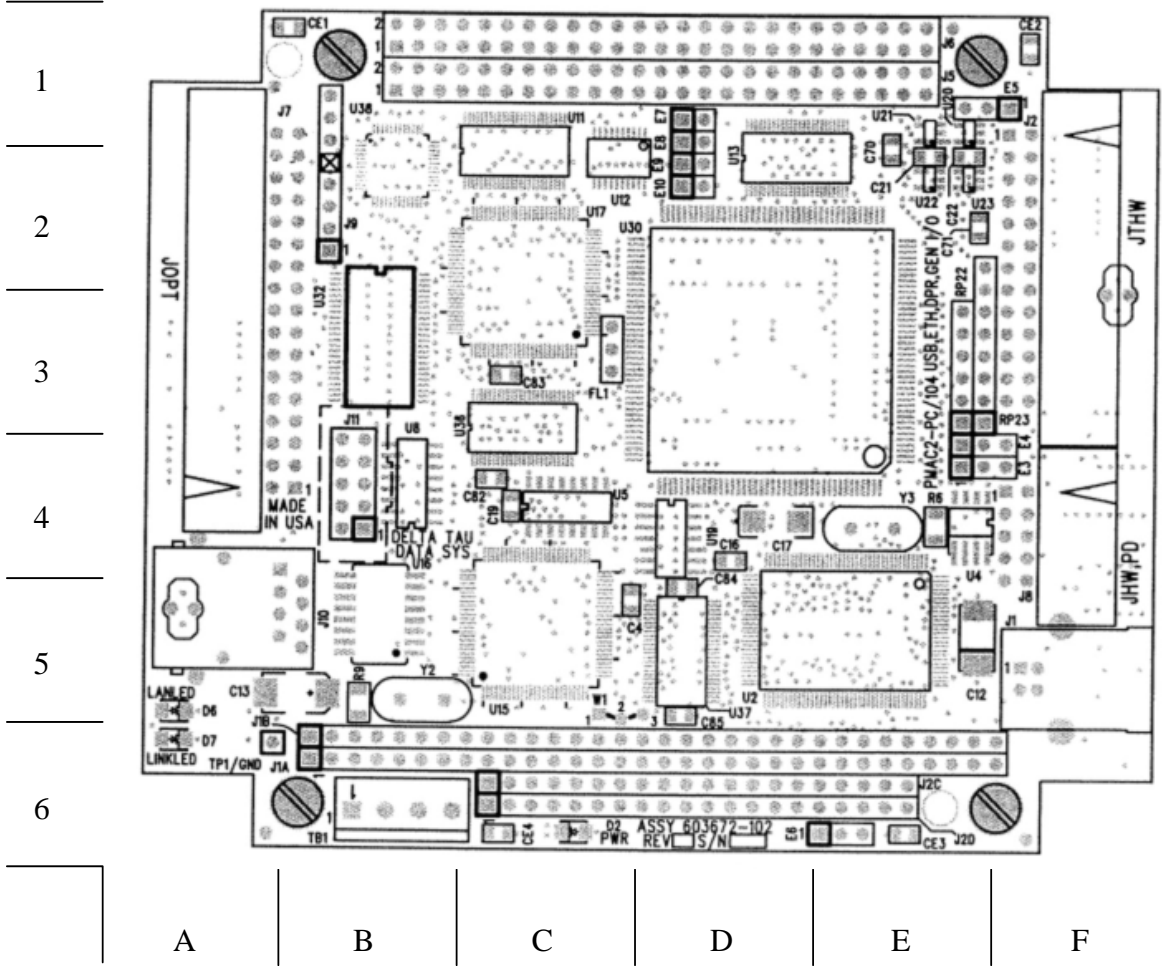

Feature	Location	Feature	Location
E3	F4	D2	C6
E4	F3	D6	A5
E5	F1	D7	A6
E6	E6	TB1	B6
E7	D1	J1	F6
E8	D1	JTHW	F2
E9	D2	JOPT	A2
E10	D2	JHW / PD	F4
RP22	E3	J10	B5
RP23	E3		

Connectors and Indicators

J1 – USB Communications Port

This connector provides access to the USB communications feature ordered through Option-1A. See the Machine Connections section for details on using this port.

J2 - Thumbwheel Multiplexer Port (JTHW Port)

The Thumbwheel Multiplexer Port, or Multiplexer Port, on the JTHW connector has eight input lines and eight output lines. The output lines can be used to multiplex large numbers of inputs and outputs on the port, and Delta Tau provides accessory boards and software structures (special M-variable definitions) to capitalize on this feature. Up to 32 of the multiplexed I/O boards may be daisy-chained on the port, in any combination.

1. 26-pin female flat cable connector T&B Ansley P/N 609-2641
2. Standard flat cable stranded 26-wire T&B Ansley P/N 171.26
3. Phoenix varioface module type FLKM 26 (male pins) P/N 22 81 05 0

J7 - General-Purpose Digital Inputs and Outputs (JOPT Port)

Acc-2P's JOPT connector provides eight general-purpose digital inputs and eight general-purpose digital outputs. Each input and each output has its own corresponding ground pin in the opposite row. The 34-pin connector was designed for easy interface to OPTO-22 or equivalent optically isolated I/O modules. Delta Tau's Acc-21F is a six-foot cable for this purpose.

1. 34-pin female flat cable connector T&B Ansley P/N 609-3441
2. Standard flat cable stranded 34-wire T&B Ansley P/N 171-34
3. Phoenix varioface module type FLKM 34 (male pins) P/N 22 81 06 3

J8 – Handwheel/Pulse and Direction Port (JHW / PD Port)

This port provides an extra encoder input or a set of pulse and direction outputs and its function is selectable by jumpers.

1. 10-pin female flat cable connector T&B Ansley P/N 609-1041
2. Standard flat cable stranded 10-wire T&B Ansley P/N 171-10
3. Phoenix varioface module type FLKM 10 (male pins) P/N 22 81 01 8

J10 – Ethernet Communications Port

This connector provides access to the Ethernet communications feature ordered through Option-1B. See the Machine Connections chapter for details on using this port.

TB1 – Power Supply Terminal Block (JPWR Connector)

In almost in all cases the PMAC2A PC/104 will be powered from the PC/104 bus when it is installed in a host computer's bus, or from the JMACH1 connector. This terminal block may be used as an alternative power supply connector or to easily measure the voltages applied to the board.

1. 4-pin terminal block, 0.150 pitch

LED Indicators

D2: When this green LED is lit, it indicates that power is applied to the +5V input.

D6 – D7: These two LEDs monitor the operation of the Ethernet communications circuitry.

BASE BOARD E-POINT JUMPER DESCRIPTIONS

E0: Forced Reset Control

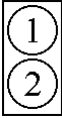
E Point and Physical Layout	Location	Description	Default
<p>E0</p> 	B3	Factory use only; the board will not operate with E0 installed.	No jumper

E1: Servo and Phase Clock Direction Control

E Point and Physical Layout	Location	Description	Default
<p>E1</p> 	B4	<p>Remove jumper for PMAC to use its internally generated servo and phase clock signals and to output these signals on the J8 serial port connector.</p> <p>Jump pins 1 and 2 for PMAC to expect to receive its servo and phase clock signals on the J8 serial port connector.</p>	No jumper installed

Note:

If the E1 jumper is ON and the servo and phase clocks are not brought in on the J8 serial port, the watchdog timer will trip immediately.

E2: CPU Frequency Select

E Point and Physical Layout	Location	Description	Default
<p>E2</p> 	B4	<p>Remove jumper for 40 MHz operation (E4 OFF also) or for 80 MHz operation (E4 ON).</p> <p>Jump pin 1 to 2 for 60 MHz operation (E4 OFF).</p>	No jumper installed

E3: Normal/Re-Initializing Power-Up/Reset

E Point and Physical Layout	Location	Description	Default
<p>E3</p> 	C4	<p>Jump pin 1 to 2 to re-initialize on power-up/reset, loading factory default settings.</p> <p>Remove jumper for normal power-up/reset, loading user-saved settings.</p>	No jumper installed

E4: CPU Frequency Select

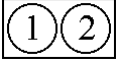
E Point and Physical Layout	Location	Description	Default
<p>E4</p> 	C4	Remove jumper for 40 MHz operation (E2 OFF also) or for 60 MHz operation (E4 ON). Jump pin 1 to 2 for 80 MHz operation (E2 OFF).	No jumper installed (standard or Option 5EF) Jumper installed (Option 5CF)



E8: Phase Clock Lines Output Enable

E Point and Physical Layout	Location	Description	Default
<p>E8</p> 	B1	Jump pin 1 to 2 to enable the PHASE clock line on the J8 connector, allowing synchronization with another PMAC. Remove jumper to disable the PHASE clock line on the J8 connector.	No Jumper

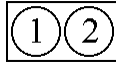
E9: Servo Clock Lines Output Enable

E Point and Physical Layout	Location	Description	Default
<p>E9</p> 	B1	Jump pin 1 to 2 to enable the SERVO clock line on the J8 connector, allowing synchronization with another PMAC. Remove jumper to disable the SERVO clock line on the J8 connector.	No Jumper

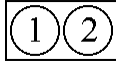
E10 – E12: Power-Up State Jumpers

E Point and Physical Layout	Location	Description	Default
<p>E10</p>  <p>E12</p> 	E5	Remove jumper E10; Jump E11; Jump E12; To read flash IC on power-up/reset Other combinations are for factory use only; the board will not operate in any other configuration.	No E10 jumper installed; Jump E11 and E12

E13: Power-Up/Reset Load Source

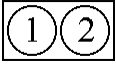
E Point and Physical Layout	Location	Description	Default
<p>E13</p> 	E5	<p>Jump pin 1 to 2 to reload firmware through serial or bus port.</p> <p>Remove jumper for normal operation.</p>	No jumper

E14: Watchdog Disable Jumper

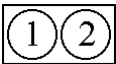
E Point and Physical Layout	Location	Description	Default
<p>E14</p> 	B3	<p>Jump pin 1 to 2 to disable Watchdog timer (for test purposes only).</p> <p>Remove jumper to enable Watchdog timer.</p>	No jumper

E15A, B, C: Flash Memory Bank Select

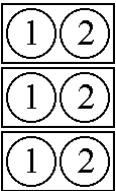
E Point and Physical Layout	Location	Description	Default
<p>E15A</p>  <p>E15C</p>	E4	<p>Remove all 3 jumpers to select flash memory bank with factory-installed firmware.</p> <p>Use other configuration to select one of the 7 other flash memory banks.</p>	No jumpers installed

E16:

ADC Inputs Enable

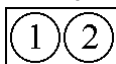
E Point and Physical Layout	Location	Description	Default
<p>E16</p> 	D1	<p>Jump pin 1 to 2 to enable the Option-12 ADC inputs.</p> <p>Remove jumper to disable the ADC inputs, which might be necessary for reading current feedback signals from digital amplifiers.</p>	No jumper

E18 – E19: PC/104 Bus Address

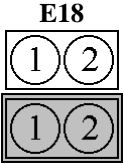
E Point and Physical Layout	Location	Description				Default
	D4	Jumpers E18 and E19 select the PC/104 bus address for communications according to the following table:				No E18 jumper installed; Jumper E19 installed
		E18	E19	Address (Hex)	Address (Dec)	
		OFF	OFF	\$200	512	
		OFF	ON	\$210	528	
		ON	OFF	\$220	544	
ON	ON	\$230	560			

Note:

Jumper E18 must be removed and jumper E19 must be installed for using either the Ethernet or USB optional methods of communication.

ACC-1P E-POINT JUMPER DESCRIPTIONS

E0: Reserved for Future Use

E Point and Physical Layout	Location	Description	Default
<p>E0</p> 	C6	For future use.	No jumper

E1 - E2: Machine Output Supply Voltage Configure

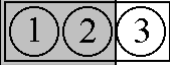
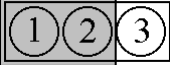
E Point and Physical Layout	Location	Description	Default
<p>E1</p> 	B2	<p>Jump pin 1 to 2 to apply +V (+5V to 24V) to pin 10 of U7 (should be ULN2803A for sink output configuration) JOPTO Machine outputs M01-M08.</p> <p>Jump pin 2 to 3 to apply GND to pin 10 of U7 (should be UDN2981A for source output configuration).</p> <p>Warning:</p> <p>The jumper setting must match the type of driver IC, or damage to the IC will result.</p>	1-2 Jumper installed
<p>E2</p> 	B2	<p>Jump pin 1 to 2 to apply GND to pin 10 of U7 (should be ULN2803A for sink output configuration).</p> <p>Jump pin 2 to 3 to apply +V (+5V to 24V) to pin 10 of U7 (should be UDN2981A for source output configuration).</p> <p>Warning:</p> <p>The jumper setting must match the type of driver IC, or damage to the IC will result.</p>	1-2 Jumper installed

E3 – E4: JHW, PD Function Select

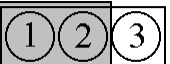
E Point and Physical Layout	Location	Description	Default
<p>E3</p> 	E4	<p>Jump pin 1 to 2 to enable handwheel channel 1 inputs.</p> <p>Jump pin 2 to 3 to enable pulse and direction channel 1 outputs.</p>	1-2 Jumper installed
<p>E4</p> 	E4	<p>Jump pin 1 to 2 to enable handwheel channel 2 inputs.</p> <p>Jump pin 2 to 3 to enable pulse and direction channel 2 outputs.</p>	1-2 Jumper installed

E5: Servo Gate Address Select

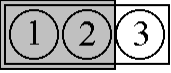
E Point and Physical Layout	Location	Description	Default
<p>E5</p> 	E5	<p>Jump pin 1 to 2 to address Acc-IP channels at the regular addresses for channels 5 to 8.</p> <p>Jump pin 2 to 3 to address Acc-IP channels at the regular addresses for channels 5 to 8 plus \$40.</p>	1-2 Jumper installed

E6: I/O Gate Address Select

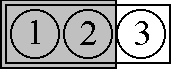
E Point and Physical Layout	Location	Description	Default
<p>E6</p> 	E5	<p>Jump pin 1 to 2 to address Acc-IP I/O ports at the regular addresses.</p> <p>Jump pin 2 to 3 to address Acc-IP I/O ports at the regular addresses plus \$40.</p>	1-2 Jumper installed

E7: Machine Input Source/Sink Control

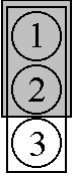
E Point and Physical Layout	Location	Description	Default
<p>E7</p> 	E5	<p>Jump pin 1 to 2 to apply +5V to input reference resistor sip pack; this will bias MI1 to MI8 inputs to +5V for OFF state; input must then be grounded for ON state.</p> <p>Jump pin 2 to 3 to apply GND to input reference resistor sip pack; this will bias MI1 to MI8 inputs to GND for OFF state; input must then be pulled up for ON state (+5V to +24V).</p>	1-2 Jumper installed

E16: ADC Inputs Enable

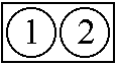
E Point and Physical Layout	Location	Description	Default
<p>E16</p> 	D1	<p>Jump pin 1 to 2 to enable the Option-12 ADC inputs.</p> <p>Remove jumper to disable the ADC inputs, which might be necessary for reading current feedback signals from digital amplifiers.</p>	No jumper

ACC-2P E-POINT JUMPER DESCRIPTIONS

E1: USB/Ethernet Micro-Controller Firmware Reload Enable

E Point and Physical Layout	Location	Description	Default
<p>E1</p> 		<p>Remove jumper to reload firmware on power-up reset.</p> <p>Jump pin 1 to 2 for normal operations</p>	1-2 Jumper Installed
<p>Note: This jumper was added on revision –103 and above of the Acc-2P</p>			

E3 – E4: JHW, PD Function Select

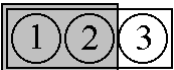
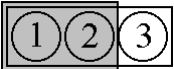
E Point and Physical Layout	Location	Description	Default
<p>E3</p> 	F4	<p>Jump pin 1 to 2 to enable handwheel channel 1 inputs.</p> <p>Jump pin 2 to 3 to enable pulse and direction channel 1 outputs.</p>	1-2 Jumper installed
<p>E4</p> 	F3	<p>Jump pin 1 to 2 to enable handwheel channel 2 inputs.</p> <p>Jump pin 2 to 3 to enable pulse and direction channel 2 outputs.</p>	1-2 Jumper installed



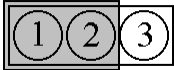

E5: I/O Gate Address Select

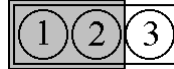
E Point and Physical Layout	Location	Description	Default
<p>E5</p> 	F1	<p>Jump pin 1 to 2 to address Acc-2P I/O ports at the regular addresses.</p> <p>Jump pin 2 to 3 to address Acc-2P I/O ports at the regular addresses plus \$40.</p>	1-2 Jumper installed

E6: Communications Port Select

E Point and Physical Layout	Location	Description	Default
<p>E6</p> 	E6	<p>Jump pin 1 to 2 to enable the PC/104 communications port.</p> <p>Jump pin 2 to 3 to enable either the USB or Ethernet communications port.</p>	1-2 Jumper installed

E7- E10: Ports Direction Control

E Point and Physical Layout	Location	Description	Default
<p>E7</p> 	D1	Install jumper to make DATx lines inputs. No jumper to make DATx lines outputs.	Jumper installed
<p>E8</p> 	D1	Install jumper to make SELx lines inputs. No jumper to make SELx lines outputs.	No jumper
<p>E9</p> 	D2	Install jumper to make MOx lines inputs. No jumper to make MOx lines outputs.	No jumper
<p>E10</p> 	D2	Install jumper to make MIx lines inputs. No jumper to make MIx lines outputs.	Jumper installed

BASE BOARD CONNECTOR PINOUTS

TB1 (JPWR): Power Supply				
Pin#	Symbol	Function	Description	
(4-Pin Terminal Block)				
1	GND	Common	Reference Voltage	
2	+5V	Input	Positive Supply Voltage	Supplies all PMAC digital circuits
3	+12V	Input	Positive Supply Voltage	Ref to digital GND
4	-12V	Input	Negative Supply Voltage	Ref to Digital GND
This terminal block can be used to provide the input for the power supply for the circuits on the PMAC board when it is not in a bus configuration. When the PMAC is in a bus configuration, these supplies automatically come through the bus connector from the bus power supply; in this case, this terminal block should not be used.				

J4 (JRS232) Serial Port Connector				
Pin#	Symbol	Function	Description	
(10-Pin Connector)				
1	PHASE	Output	Phasing Clock	
2	DTR	Bidirect	Data Terminal Ready	Tied to "DSR"
3	TXD/	Input	Receive Data	Host transmit data
4	CTS	Input	Clear to Send	Host ready bit
5	RXD/	Output	Send Data	Host receive data
6	RTS	Output	Request to Send	PMAC ready bit
7	DSR	Bidirect	Data Set Ready	Tied to "DTR"
8	SERVO	Output	Servo Clock	
9	GND	Common	PMAC Common	
10	+5V	Output	+5Vdc Supply	Power supply out

J3 (JMACH1): Machine Port Connector

(50-Pin Header)

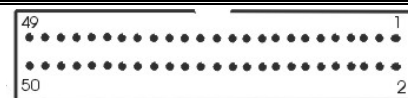

Top View

Pin#	Symbol	Function	Description	Notes
1	+5V	Output	+5V Power	For encoders, 1
2	+5V	Output	+5V Power	For encoders, 1
3	GND	Common	Digital Common	
4	GND	Common	Digital Common	
5	CHA1	Input	Encoder A Channel Positive	2
6	CHA2	Input	Encoder A Channel Positive	2
7	CHA1/	Input	Encoder A Channel Negative	2,3
8	CHA2/	Input	Encoder A Channel Negative	2,3
9	CHB1	Input	Encoder B Channel Positive	2
10	CHB2	Input	Encoder B Channel Positive	2
11	CHB1/	Input	Encoder B Channel Negative	2,3
12	CHB2/	Input	Encoder B Channel Negative	2,3
13	CHC1	Input	Encoder C Channel Positive	2
14	CHC2	Input	Encoder C Channel Positive	2
15	CHC1/	Input	Encoder C Channel Negative	2,3
16	CHC2/	Input	Encoder C Channel Negative	2,3
17	CHA3	Input	Encoder A Channel Positive	2
18	CHA4	Input	Encoder A Channel Positive	2
19	CHA3/	Input	Encoder A Channel Negative	2,3
20	CHA4/	Input	Encoder A Channel Negative	2,3
21	CHB3	Input	Encoder B Channel Positive	2
22	CHB4	Input	Encoder B Channel Positive	2
23	CHB3/	Input	Encoder B Channel Negative	2,3
24	CHB4/	Input	Encoder B Channel Negative	2,3
25	CHC3	Input	Encoder C Channel Positive	2
26	CHC4	Input	Encoder C Channel Positive	2
27	CHC3/	Input	Encoder C Channel Negative	2,3
28	CHC4/	Input	Encoder C Channel Negative	2,3
29	DAC1	Output	Analog Output Positive 1	4
30	DAC2	Output	Analog Output Positive 2	4
31	DAC1/	Output	Analog Output Negative 1	4,5
32	DAC2/	Output	Analog Output Negative 2	4,5
33	AENA1/	Output	Amplifier-Enable 1	
34	AENA2/	Output	Amplifier -Enable 2	
35	FAULT1/	Input	Amplifier -Fault 1	6
36	FAULT2/	Input	Amplifier -Fault 2	6
37	DAC3	Output	Analog Output Positive 3	4
38	DAC4	Output	Analog Output Positive 4	4
39	DAC3/	Output	Analog Output Negative 3	4,5

J3 JMACH1 (50-Pin Header) (Continued)		 Top View		
Pin#	Symbol	Function	Description	Notes
40	DAC4/	Output	Analog Output Negative 4	4,5
41	AENA3/	Output	Amplifier -Enable 3	
42	AENA4/	Output	Amplifier -Enable 4	
43	FAULT3/	Input	Amplifier -Fault 3	6
44	FAULT4/	Input	Amplifier -Fault 4	6
45	ADCIN_1	Input	Analog Input 1	Option-12 required
46	ADCIN_2	Input	Analog Input 2	Option-12 required
47	FLT_FLG_V	Input	Amplifier Fault pull-up V+	
48	GND	Input	Analog Common	
49	A+15V	Input	DACs +15V Supply	
50	A-15V	Input	DACs -15V Supply	
<p>The J3 connector is used to connect PMAC to the first 4 channels (Channels 1, 2, 3, and 4) of servo amps and encoders.</p> <p>Note 1: In standalone applications, these lines can be used as +5V power supply inputs to power PMAC's digital circuitry.</p> <p>Note 2: Referenced to digital common (GND). Maximum of $\pm 12V$ permitted between this signal and its complement.</p> <p>Note 3: Leave this input floating if not used (i.e. digital single-ended encoders).</p> <p>Note 4: $\pm 10V$, 10 mA max, referenced to common ground (GND).</p> <p>Note 5: Leave floating if not used. Do not tie to GND.</p> <p>Note 6: Functional polarity controlled by variable Ix25. Must be conducting to 0V (usually GND) to produce a 0 in PMAC software. Automatic fault function can be disabled with Ix25.</p>				

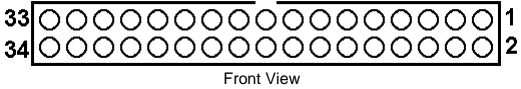
J4 (JMACH2): Machine Port Baseboard Connector (34-Pin Header)				
Pin#	Symbol	Function	Description	Notes
1	FLG_1_2_V	Input	Flags 1-2 Pull-Up	
2	FLG_3_4_V	Input	Flags 3-4 Pull-Up	
3	GND	Common	Digital Common	
4	GND	Common	Digital Common	
5	HOME1	Input	Home-Flag 1	10
6	HOME2	Input	Home-Flag 2	10
7	PLIM1	Input	Positive End Limit 1	8,9
8	PLIM2	Input	Positive End Limit 2	8,9
9	MLIM1	Input	Negative End Limit 1	8,9
10	MLIM2	Input	Negative End Limit 2	8,9
11	USER1	Input	User Flag 1	
12	USER2	Input	User Flag 2	
13	PUL_1	Output	Pulse Output 1	
14	PUL_2	Output	Pulse Output 2	
15	DIR_1	Output	Direction Output 1	
16	DIR_2	Output	Direction Output 2	
17	EQU1	Output	Encoder Comp-Equal 1	
18	EQU2	Output	Encoder Comp-Equal 2	
19	HOME3	Input	Home-Flag 3	10
20	HOME4	Input	Home-Flag 4	10
21	PLIM3	Input	Positive End Limit 3	8,9
22	PLIM4	Input	Positive End Limit 4	8,9
23	MLIM3	Input	Negative End Limit 3	8,9
24	MLIM4	Input	Negative End Limit 4	8,9
25	USER1	Input	User Flag 1	
26	USER2	Input	User Flag 2	
27	PUL_3	Output	Pulse Output 3	
28	PUL_4	Output	Pulse Output 4	
29	DIR_3	Output	Direction Output 3	
30	DIR_4	Output	Direction Output 4	
31	EQU3	Output	Encoder Comp-Equal 3	
32	EQU4	Output	Encoder Comp-Equal 4	
33	B_WDO	Output	Watchdog Out	Indicator/driver
34	No Connect			

Note 1: Pins marked *PLIMn* should be connected to switches at the *positive* end of travel. Pins marked *MLIMn* should be connected to switches at the *negative* end of travel.

Note 2: Must be conducting to 0V (usually GND) for PMAC to consider itself not into this limit. Automatic limit function can be disabled with Ix25.

Note 3: Functional polarity for homing or other trigger use of HOMEn controlled by Encoder/Flag Variable I9n2. HMFLn selected for trigger by Encoder/Flag Variable I9n3. Must be conducting to 0V (usually GND) to produce a 0 in PMAC software.

ACC-1P CONNECTOR PINOUTS

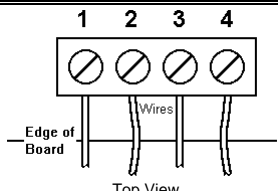
TB1 (JPWR): Power Supply				
(4-Pin Terminal Block)				
Pin#	Symbol	Function	Description	Notes
1	GND	Common	Reference Voltage	
2	+5V	Input	Positive Supply Voltage	Supplies all PMAC digital circuits
3	+12V	Input	Positive Supply Voltage	REF to digital GND
4	-12V	Input	Negative Supply Voltage	REF to digital GND
<p>This terminal block can be used to provide the input for the power supply for the circuits on the PMAC board when it is not in a bus configuration. When the PMAC is in a bus configuration, these supplies automatically come through the bus connector from the bus power supply; in this case, this terminal block should not be used.</p>				

J2 (JTHW): Multiplexer Port Connector

(26-Pin Connector)

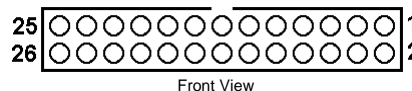

Pin#	Symbol	Function	Description	Notes
1	GND	Common	PMAC Common	
2	GND	Common	PMAC Common	
3	DAT0	Input	Data-0 Input	Data input from multiplexed accessory
4	SEL0	Output	Select-0 Output	Multiplexer select output
5	DAT1	Input	Data -1 Input	Data input from multiplexed accessory
6	SEL1	Output	Select -1 Output	Multiplexer select output
7	DAT2	Input	Data -2 Input	Data input from multiplexed accessory
8	SEL2	Output	Select -2 Output	Multiplexer select output
9	DAT3	Input	Data -3 Input	Data input from multiplexed accessory
10	SEL3	Output	Select -3 Output	Multiplexer select output
11	DAT4	Input	Data -4 Input	Data input from multiplexed accessory
12	SEL4	Output	Select -4 Output	Multiplexer select output
13	DAT5	Input	Data -5 Input	Data input from multiplexed accessory
14	SEL5	Output	Select -5 Output	Multiplexer select output
15	DAT6	Input	Data -6 Input	Data input from multiplexed accessory
16	SEL6	Output	Select -6 Output	Multiplexer select output
17	DAT7	Input	Data -7 Input	Data input from multiplexed accessory
18	SEL7	Output	Select -7 Output	Multiplexer select output
19	N.C.	N.C.	No Connection	
20	GND	Common	PMAC Common	
21	N.C.	Output	Buffer Request	Low is Buffer Request
22	GND	Common	PMAC Common	
23	N.C.	Output	In Position	Low is In Position
24	GND	Common	PMAC Common	
25	+5V	Output	+5VDC Supply	Power supply out
26	N.C.	Input	PMAC Reset	Low is Reset

The JTHW multiplexer port provides eight inputs and eight outputs at TTL levels. While these I/O can be used in unmultiplexed form for 16 discrete I/O points, most users will utilize PMAC software and accessories to use this port in multiplexed form to greatly multiply the number of I/O that can be accessed on this port. In multiplexed form, some of the SELn outputs are used to select which of the multiplexed I/O are to be accessed.

J3 (JMACH1): Machine Port Connector (50-Pin Header)

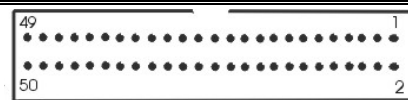

Pin#	Symbol	Function	Description	Notes
1	+5V	Output	+5V Power	For Encoders, 1
2	+5V	Output	+5V Power	For Encoders, 1
3	GND	Common	Digital Common	
4	GND	Common	Digital Common	
5	CHA5	Input	Encoder A Channel Positive	2
6	CHA6	Input	Encoder A Channel Positive	2
7	CHA5/	Input	Encoder A Channel Negative	2,3
8	CHA6/	Input	Encoder A Channel Negative	2,3
9	CHB5	Input	Encoder B Channel Positive	2
10	CHB6	Input	Encoder B Channel Positive	2
11	CHB5/	Input	Encoder B Channel Negative	2,3
12	CHB6/	Input	Encoder B Channel Negative	2,3
13	CHC5	Input	Encoder C Channel Positive	2
14	CHC6	Input	Encoder C Channel Positive	2
15	CHC5/	Input	Encoder C Channel Negative	2,3
16	CHC6/	Input	Encoder C Channel Negative	2,3
17	CHA7	Input	Encoder A Channel Positive	2
18	CHA8	Input	Encoder A Channel Positive	2
19	CHA7/	Input	Encoder A Channel Negative	2,3
20	CHA8/	Input	Encoder A Channel Negative	2,3
21	CHB7	Input	Encoder B Channel Positive	2
22	CHB8	Input	Encoder B Channel Positive	2
23	CHB7/	Input	Encoder B Channel Negative	2,3
24	CHB8/	Input	Encoder B Channel Negative	2,3
25	CHC7	Input	Encoder C Channel Positive	2
26	CHC8	Input	Encoder C Channel Positive	2
27	CHC7/	Input	Encoder C Channel Negative	2,3
28	CHC8/	Input	Encoder C Channel Negative	2,3
29	DAC5	Output	Analog Out Positive 5	4
30	DAC6	Output	Analog Out Positive 6	4
31	DAC5/	Output	Analog Out Negative 5	4,5
32	DAC6/	Output	Analog Out Negative 6	4,5
33	AENA5/	Output	Amplifier-Enable 5	
34	AENA6/	Output	Amplifier -Enable 6	
35	FAULT5/	Input	Amplifier -Fault 5	6
36	FAULT6/	Input	Amplifier -Fault 6	6
37	DAC7	Output	Analog Out Positive 7	4
38	DAC8	Output	Analog Out Positive 8	4
39	DAC7/	Output	Analog Out Negative 7	4,5

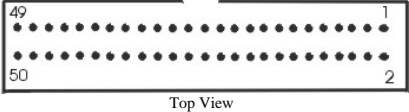
J3 JMACH1 (50-Pin-Header) (Continued)				
Pin#	Symbol	Function	Description	Notes
40	DAC8/	Output	Analog Out Negative 8	4,5
41	AENA7/	Output	Amplifier-Enable 7	
42	AENA8/	Output	Amplifier -Enable 8	
43	FAULT7/	Input	Amplifier -Fault 7	6
44	FAULT8/	Input	Amplifier -Fault 8	6
45	ADCIN_1	Input	Analog Input 1	Option-2 required
46	ADCIN_2	Input	Analog Input 2	Option-2 required
47	FLT_FLG_V	Input	Amplifier Fault pull-up V+	
48	GND	Input	Analog Common	
49	A+15V	Input	DACs +15V Supply	
50	A-15V	Input	DACs -15V Supply	

The J3 connector is used to connect PMAC to the second 4 channels (Channels 5, 6, 7, and 8) of servo amps and encoders.

Note 1: In standalone applications, these lines can be used as +5V power supply inputs to power PMAC's digital circuitry.

Note 2: Referenced to digital common (GND). Maximum of $\pm 12V$ permitted between this signal and its complement.

Note 3: Leave this input floating if not used (i.e. digital single-ended encoders).

Note 4: $\pm 10V$, 10 mA max, referenced to common ground (GND).

Note 5: Leave floating if not used; do not tie to GND.

Note 6: Functional polarity controlled by variable Ix25. Must be conducting to 0V (usually GND) to produce a 0 in PMAC software. Automatic fault function can be disabled with Ix25.

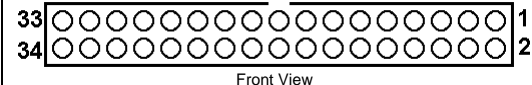
J4 (JMACH2): Machine Port Connector (34-Pin Header)				
Pin#	Symbol	Function	Description	Notes
1	FLG_5_6_V	Input	Flags 5-6 Pull-Up	
2	FLG_7_8_V	Input	Flags 7-8 Pull-Up	
3	GND	Common	Digital Common	
4	GND	Common	Digital Common	
5	HOME5	Input	Home-Flag 5	10
6	HOME6	Input	Home-Flag 6	10
7	PLIM5	Input	Positive End Limit 5	8,9
8	PLIM6	Input	Positive End Limit 6	8,9
9	MLIM5	Input	Negative End Limit 5	8,9
10	MLIM6	Input	Negative End Limit 6	8,9
11	USER5	Input	User Flag 5	
12	USER6	Input	User Flag 6	
13	PUL_5	Output	Pulse Output 5	
14	PUL_6	Output	Pulse Output 6	
15	DIR_5	Output	Direction Output 5	
16	DIR_6	Output	Direction Output 6	
17	EQU5	Output	Encoder Comp-Equal 5	
18	EQU6	Output	Encoder Comp-Equal 6	
19	HOME7	Input	Home Flag 7	10
20	HOME8	Input	Home Flag 8	10
21	PLIM7	Input	Positive End Limit 7	8,9
22	PLIM8	Input	Positive End Limit 8	8,9
23	MLIM7	Input	Negative End Limit 7	8,9
24	MLIM8	Input	Negative End Limit 8	8,9
25	USER7	Input	User Flag 7	
26	USER8	Input	User Flag 8	
27	PUL_7	Output	Pulse Output 7	
28	PUL_8	Output	Pulse Output 8	
29	DIR_7	Output	Direction Output 7	
30	DIR_8	Output	Direction Output 8	
31	EQU7	Output	Encoder Comp-Equal 7	
32	EQU8	Output	Encoder Comp-Equal 8	
33	B_WDO	Output	Watchdog Out	Indicator/Driver
34	No Connect			

Note 1: Pins marked *PLIMn* should be connected to switches at the *positive* end of travel. Pins marked *MLIMn* should be connected to switches at the negative end of travel.

Note 2: Must be conducting to 0V (usually GND) for PMAC to consider itself not into this limit. Automatic limit function can be disabled with Ix25.

Note 3: Functional polarity for homing or other trigger use of HOME_n controlled by Encoder/Flag Variable I9n2. HMFL_n selected for trigger by Encoder/Flag Variable I9n3. Must be conducting to 0V (usually GND) to produce a 0 in PMAC software.

J7 (JOPTO): I/O Port Connector

(34-Pin Connector)

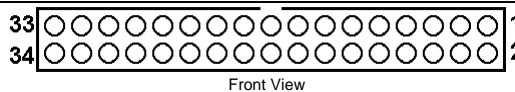

Pin#	Symbol	Function	Description	Notes
1	MI8	Input	Machine Input 8	Low is TRUE
2	GND	Common	PMAC Common	
3	MI7	Input	Machine Input 7	Low is TRUE
4	GND	Common	PMAC Common	
5	MI6	Input	Machine Input 6	Low is TRUE
6	GND	Common	PMAC Common	
7	MI5	Input	Machine Input 5	Low is TRUE
8	GND	Common	PMAC Common	
9	MI4	Input	Machine Input 4	Low is TRUE
10	GND	Common	PMAC Common	
11	MI3	Input	Machine Input 3	Low is TRUE
12	GND	Common	PMAC Common	
13	MI2	Input	Machine Input 2	Low is TRUE
14	GND	Common	PMAC Common	
15	MI1	Input	Machine Input 1	Low is TRUE
16	GND	Common	PMAC Common	
17	MO8	Output	Machine Output 8	Low-TRUE (Sinking) High-TRUE (Sourcing)
18	GND	Common	PMAC Common	
19	MO7	Output	Machine Output 7	" "
20	GND	Common	PMAC Common	
21	MO6	Output	Machine Output 6	" "
22	GND	Common	PMAC Common	
23	MO5	Output	Machine Output 5	" "
24	GND	Common	PMAC Common	
25	MO4	Output	Machine Output 4	" "
26	GND	Common	PMAC Common	
27	MO3	Output	PMAC Common	" "
28	GND	Common	PMAC COMMON	
29	MO2	Output	Machine Output 2	" "
30	GND	Common	PMAC Common	
31	MO1	Output	Machine Output 1	" "
32	GND	Common	PMAC Common	
33	+V	Input/Output	+V Power I/O	+V = +5V to +24V +5V out from PMAC, +5 to +24V in from external source, DIODE isolation from PMAC
34	GND	Common	PMAC Common	

This connector provides means for eight general-purpose inputs and eight general-purpose outputs. Inputs and outputs may be configured to accept or provide either +5V or +24V signals. Outputs can be made sourcing with an IC (U7 to UDN2981) and jumper (E1 and E2) change. E7 controls whether the inputs are pulled up or down internally. Outputs are rated at 100mA per channel.

J8 (JHW) Handwheel Encoder Connector			
Pin#	Symbol	Function	Description
1	GND	Common	Reference voltage
2	HWA1+ / PUL1+	Input/Output	HW1 Channel A or pulse output selected by jumpers E3 and E4
3	HWA1- / PUL1-	Input/Output	HW 1 Channel A or pulse output selected by jumpers E3 and E4
4	HWB1+ / DIR1+	Input/Output	HW 1 Channel B or direction output selected by jumpers E3 and E4
5	HWB1- / DIR1-	Input/Output	HW 1 Channel B or direction output selected by jumpers E3 and E4
6	HWA2+ / PUL2+	Input/Output	HW 2 Channel A or pulse output selected by jumpers E3 and E4
7	HWA2- / PUL2-	Input/Output	HW 2 Channel A or pulse output selected by jumpers E3 and E4
8	HWB2+ / DIR2+	Input/Output	HW 2 Channel B or direction output selected by E3 and E4
9	HWB2- / DIR2-	Input/Output	HW 2 Channel B or direction output selected by E3 and E4
10	+5V	Output	Supply voltage

ACC-2P CONNECTOR PINOUTS

TB1 (JPWR): Power Supply				
(4-Pin Terminal Block)				
Pin#	Symbol	Function	Description	Notes
1	GND	Common	Reference Voltage	
2	+5V	Input	Positive Supply Voltage	Supplies all PMAC digital circuits
3	+12V	Input	Positive Supply Voltage	Ref to digital GND
4	-12V	Input	Negative Supply Voltage	Ref TO Digital GND
<p>This terminal block can be used to provide the input for the power supply for the circuits on the PMAC board when it is not in a bus configuration. When the PMAC is in a bus configuration, these supplies automatically come through the bus connector from the bus power supply; in this case, this terminal block should not be used.</p>				

J1 (USB) Universal Serial Bus Port (Optional)		
Pin #	Symbol	Function
1	VCC	N.C.
2	D-	DATA-
3	D+	DATA+
4	GND	GND
5	SHELL	SHIELD
6	SHELL	SHIELD
<p>This connector is to be used in conjunction with USB A-B cable, which can be purchased from any local computer store and it is provided when Acc-2P Option 1A is ordered. The A connector is connected to a PC or Hub device; the B connector plugs into this port.</p>		

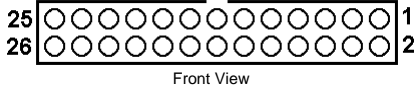
J2 (JTHW): Multiplexer Port Connector				
(26-Pin Connector)				
Pin#	Symbol	Function	Description	Notes
1	GND	Common	PMAC Common	
2	GND	Common	PMAC Common	
3	DAT0	Input	Data-0 Input	Data input from multiplexed accessory
4	SEL0	Output	Select-0 Output	Multiplexer select output
5	DAT1	Input	Data -1 Input	Data input from multiplexed accessory
6	SEL1	Output	Select -1 Output	Multiplexer select output
7	DAT2	Input	Data -2 Input	Data input from multiplexed accessory
8	SEL2	Output	Select -2 Output	Multiplexer select output
9	DAT3	Input	Data -3 Input	Data input from multiplexed accessory
10	SEL3	Output	Select -3 Output	Multiplexer select output
11	DAT4	Input	Data -4 Input	Data input from multiplexed accessory
12	SEL4	Output	Select -4 Output	Multiplexer select output
13	DAT5	Input	Data -5 Input	Data input from multiplexed accessory
14	SEL5	Output	Select -5 Output	Multiplexer select output
15	DAT6	Input	Data -6 Input	Data input from multiplexed accessory
16	SEL6	Output	Select -6 Output	Multiplexer select output
17	DAT7	Input	Data -7 Input	Data input from multiplexed accessory
18	SEL7	Output	Select -7 Output	Multiplexer select output
19	N.C.	N.C.	No Connection	
20	GND	Common	PMAC Common	
21	N.C.	Output	Buffer Request	Low is Buffer Request
22	GND	Common	PMAC Common	
23	N.C.	Output	In Position	Low is In Position
24	GND	Common	PMAC Common	
25	+5V	Output	+5VDC Supply	Power supply out
26	N.C.	Input	PMAC Reset	Low is Reset

The JTHW multiplexer port provides 8 inputs and 8 outputs at TTL levels. While these I/O can be used in unmultiplexed form for 16 discrete I/O points, most users will utilize PMAC software and accessories to use this port in multiplexed form to greatly multiply the number of I/O that can be accessed on this port. In multiplexed form, some of the SELn outputs are used to select which of the multiplexed I/O are to be accessed.

The direction of the input and output lines on this connector are set by jumpers E7 and E8. If E7 is removed or E8 is installed then the multiplexing feature if the JTHW port cannot be used.

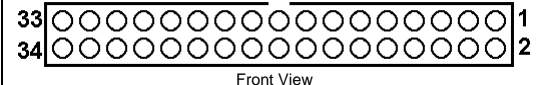
J7 (JOPT): I/O Port Connector					
(34-Pin Connector)				Front View	
Pin#	Symbol	Function	Description	Notes	
1	MI8	Input	Machine Input 8	Direction selectable	
2	GND	Common	PMAC Common		
3	MI7	Input	Machine Input 7	Direction selectable	
4	GND	Common	PMAC Common		
5	MI6	Input	Machine Input 6	Direction selectable	
6	GND	Common	PMAC Common		
7	MI5	Input	Machine Input 5	Direction selectable	
8	GND	Common	PMAC Common		
9	MI4	Input	Machine Input 4	Direction selectable	
10	GND	Common	PMAC Common		
11	MI3	Input	Machine Input 3	Direction selectable	
12	GND	Common	PMAC Common		
13	MI2	Input	Machine Input 2	Direction selectable	
14	GND	Common	PMAC Common		
15	MI1	Input	Machine Input 1	Direction selectable	
16	GND	Common	PMAC Common		
17	MO8	Output	Machine Output 8	Direction selectable	
18	GND	Common	PMAC Common		
19	MO7	Output	Machine Output 7	Direction selectable	
20	GND	Common	PMAC Common		
21	MO6	Output	Machine Output 6	Direction selectable	
22	GND	Common	PMAC Common		
23	MO5	Output	Machine Output 5	Direction selectable	
24	GND	Common	PMAC Common		
25	MO4	Output	Machine Output 4	Direction selectable	
26	GND	Common	PMAC Common		
27	MO3	Output	Machine Output 3	Direction selectable	
28	GND	Common	PMAC Common		
29	MO2	Output	Machine Output 2	Direction selectable	
30	GND	Common	PMAC Common		
31	MO1	Output	Machine Output 1	Direction selectable	
32	GND	Common	PMAC Common		
33	+5	Output	+5 Power I/O		
34	GND	Common	PMAC Common		

This connector provides means for 16 general-purpose inputs or outputs at TTL levels. The direction of the input and output lines on this connector are set by jumpers E9 and E10. Further software settings are required to configure this port. See the Software Setup section for details.

J8 (JHW) Handwheel Encoder Connector

Pin#	Symbol	Function	Description
1	GND	Common	Reference voltage
2	HWA1+ / PUL1+	Input/Output	HW1 channel A or pulse output selected by jumpers E3 and E4
3	HWA1- / PUL1-	Input/Output	HW1 channel a or pulse output selected by jumpers E3 and E4
4	HWB1+ / DIR1+	Input/Output	HW1 channel b or direction output selected by jumpers E3 and E4
5	HWB1- / DIR1-	Input/Output	HW1 channel b or direction output selected by jumpers E3 and E4
6	HWA2+ / PUL2+	Input/Output	HW2 channel a or pulse output selected by jumpers E3 and E4
7	HWA2- / PUL2-	Input/Output	HW2 channel a or pulse output selected by jumpers E3 and E4
8	HWB2+ / DIR2+	Input/Output	HW2 channel b or direction output selected by jumpers E3 and E4
9	HWB2- / DIR2-	Input/Output	HW2 channel b or direction output selected by jumpers E3 and E4
10	+5V	Output	Supply voltage

J10 Ethernet Port (Optional)

Pin #	Function
1	TXD+
2	TXD-
3	RXD+
4	No Connect
5	No Connect
6	RXD-
7	No Connect
8	No Connect
9	No Connect
10	No Connect

This connector is used for Ethernet communications from the Acc-2P to a PC, and it is provided when Acc-2P Option 1B is ordered. The appropriate Category 5 10/100-Base T network cable that mates to this connector can be readily purchased from any local computer store. The type of network cable to purchase depends on the configuration to the host PC.

When making a direct connection to a Host communication Ethernet card in a PC a cat 5 networking crossover cable must be used. A standard cat 5 straight through networking cable cannot be used in this scenario. When using a connection to a network hub or switch, the standard cat 5 straight through networking cable must be used, and not a crossover cable.